

HAFNER

HAFNER Pneumatik

Excellence in Pneumatics



NAMUR-valves and accessories for smart valve automation

HAFNER offers a unique range of NAMUR-valves and accessories for valve automation.
Find the perfect set-up for your process valve.

HAFNER always offers the right pilot-valve
for your process valves.

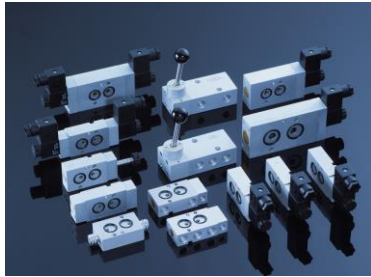

Page

1. Valves for double acting actuators	3
2. Valves for single-acting actuators	4
3. NAMUR-flex for single- and double acting	6
4. 3-position valves with fail-safe position – ideal for filling & dosing	7
5. Different types of actuation	9
6. When to use air / mechanic spring return	10
7. Material options	11
8. Temperature options	12
9. Solenoid systems: IP-class and power consumption	13
10. Protection of exhaust ports against water and dirt	14
11. NAMUR1 vs. NAMUR2 interface	15
12. Port orientation: 701 vs. 711	17
13. Speed control / Quick exhaust / 2-speed valve	18
14. Explosion proof	27
15. SIL	29
16. Position feedback	30

You have to realize a special control task?
Check our NAMUR-accessories.



Page

17. Fail-in-place / stay-put	31
18. Fail-exhaust	34
19. 6/2-way for bypass, fail-open/close, selection between two sources	35
20. Manual block- and vent	38
21. Manual block- and block	39
22. Short-circuit for manual gearboxes	40
23. Pneumo-manual override for positioners	41
24. Block for butterfly valves with inflatable valve seat	42
25. Latch-lock	44
26. Manual reset button	45
27. Mounting accessories	46
28. Cylinder-valve-combinations	49
29. Linear cylinders with NAMUR-interface	50

1. Valves for double acting actuators: Monostable, bistable as well as 5/3-way valves.

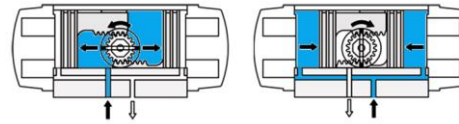

Single solenoid (spring-return)

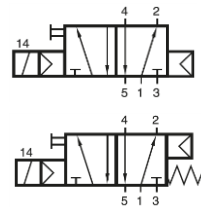

Air spring

Combined spring

Double solenoid

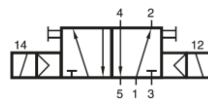

5/3-way

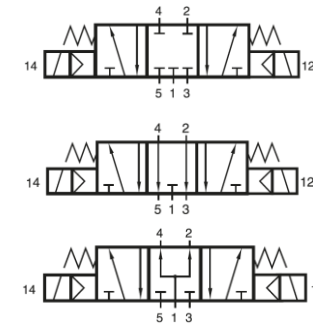

Centre closed

Centre exhausted

Centre pressurised

Available port sizes	G 1/4" - G 3/8" - G 1/2"
Air-flow	1.250 - 2.250 - 3.000
Interface	NAMUR 1 (1/4") and NAMUR 2 (1/2")
Port-scheme	701/711
Threads	NPT or BSP
Power consumption	3.0 Watt (standard), on request 2.0 Watt and 1.8 Watt

Further variants of 3-position valves can be found on page 7.

2. Valves for single acting actuators: Monostable with exhaust-air recirculation.

Monostable (spring-return)



The exhaust-air recirculation in single-acting actuators is important to protect the springs from corrosion.

All HAFNER 3-way NAMUR-valves ensure a pressure compensation during the switching process from the actuation to the spring chamber. No ambient atmosphere will be sucked into the actuator.

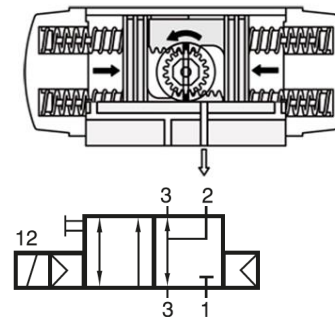
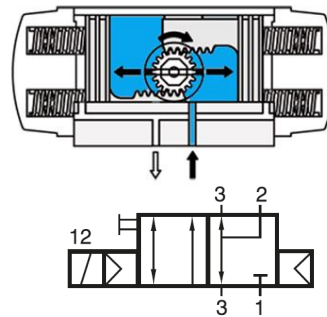
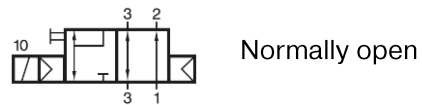
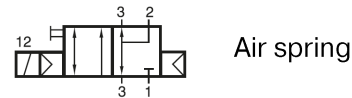

Available port sizes	G 1/4" - G 3/8" - G 1/2"
Air-flow	1.250 - 2.250 - 3.000
Interface	NAMUR 1 (1/4") and NAMUR 2 (1/2")
Port-scheme	701/711
Threads	NPT or BSP
Power consumption	3.0 Watt (standard), on request 2.0 Watt and 1.8 Watt

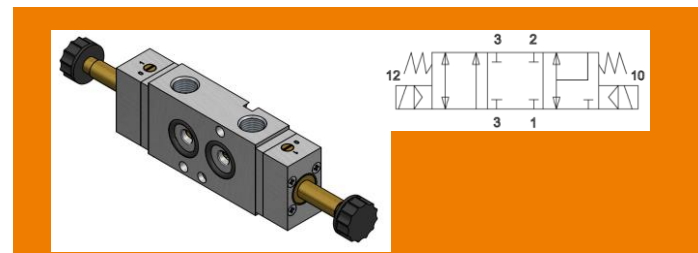

Available on request:
3-position valve with a closed middle position.
With the MNH 331 701 valve even a spring-return actuator can be kept in intermediate positions.

2. Valves for single acting actuators:

The exhaust-air recirculation is a challenge if the actuator is remotely controlled.

UB 701: Air-recirculation block



The UB 701 block guarantees, that the exhaust air from the actuation chamber is going into the spring chamber and for sure no ambient atmosphere. It thereby protects the springs from corrosion.

The use of the air-recirculation block makes sense, if:

1. The 3/2-way pilot valve is remotely installed (e.g. in a control cabinet)
2. Corrosive, wet, or explosive atmosphere is around



A silencer in the spring chamber offers only some protection against dirt not against water or aggressive gases.

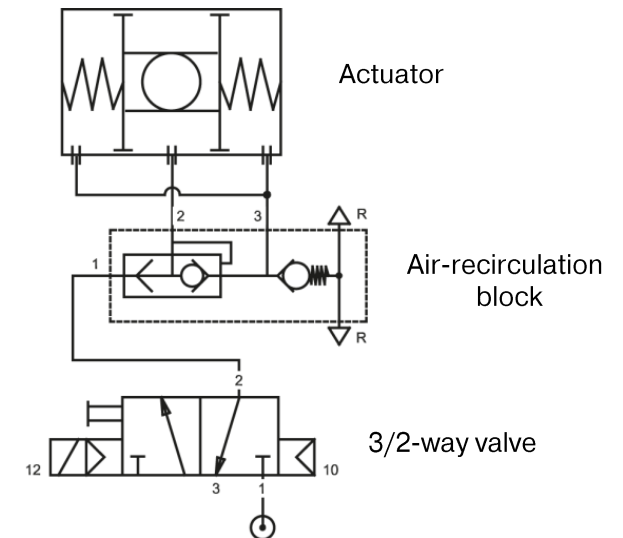
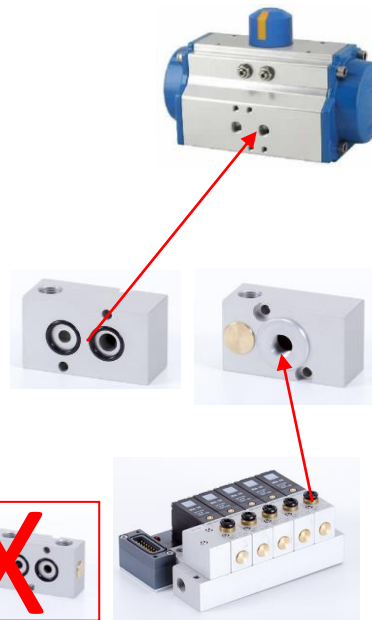

3. The NAMUR-flex is designed for single- and double acting actuators.

MNH 350 701: NAMUR-Flex



Innovative design:

- 5/2-way valve that can be used on double acting actuators
- FP 701 plate turns it into a 3/2-way valve with “purge” function for single acting actuators
- Also available with the “flex-regulator” for precise speed regulation



MNH 350 701 = 5/2-way, air spring
 MNH 351 701 = 5/2-way, combined spring



+ FP 701

= 3/2-way



+ DRF 3 601
 + DRN 5 ...

= 3/2-way with speed control
 = 5/2-way with speed control

4. 3-position valves to open, close and keep an actuator in intermediate positions with additional fail-safe function. Ideal for filling- and dosing applications.

For single-acting actuators

Type MNH 334 701 DK

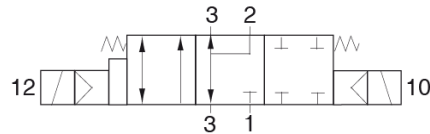

- Fail-exhaust in case of air or electricity failure
- With dominating piston

- Dosed opening: Current at solenoid 10 + impulses to solenoid 12
- Dosed closing: Impulses at solenoid 10

Type MNB 334 701 (SR)

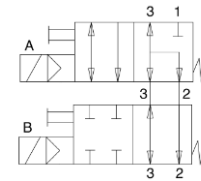
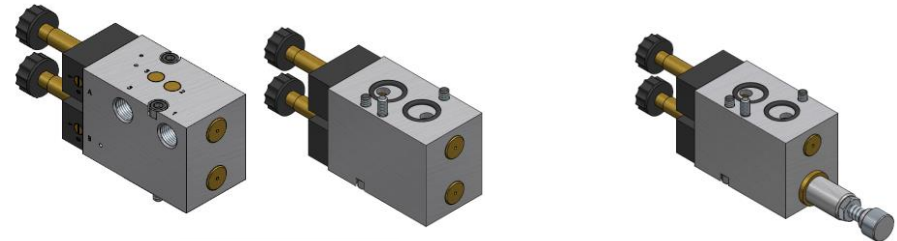

MNB 334 701

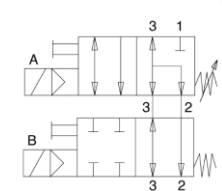

MNB 334 701 SR

- Both solenoids off: Actuator exhausts = fail-safe
- Coil A with current: Actuator opens
- Coil B with current: Actuator stays in position
- Coil A+B with current: Actuator stays in position too

- Dosed opening: Current at solenoid A + impulses to solenoid B
- Dosed closing: Impulses at solenoid B

4. 3-position valves to open, close and keep an actuator in intermediate positions with additional fail-safe function. Ideal for filling- and dosing applications.

For double-acting actuator

Type MNH 534 701

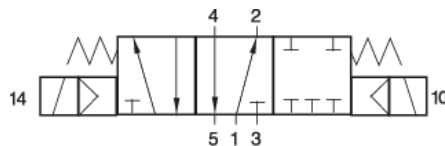

- Fail-open / close in case of electricity failure

Type MNHOH 531 701

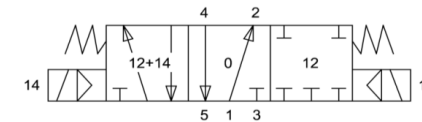
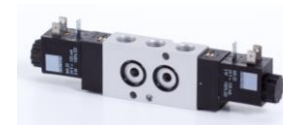

- Fail-open / close in case of electricity failure
- Please note: true middle position is „12“, but valve will switch to position „0“ as soon as minimum actuating pressure (~ 3 bar) is reached due to a normally open operator system on solenoid side „12“

Function:

- Dosed opening: Current at solenoid 12
+ impulses to solenoid 14
- Dosed closing: Impulses at solenoid 12

5. Our customers have choice of different actuations.

Electric actuation

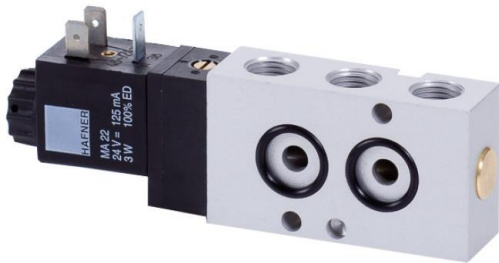

Pneumatic actuation



Manual actuation (hand lever)



Electric on / Manual off



Non standard item! Additional information on page 41

6. Monostable valves can either have a pure pneumatic or a combined spring-return (air + mechanic).

When to use which type?

In order to decide whether an air- or combined spring should be used, the following questions have to be answered:

1. What shall happen if the **electricity** cut-off?
2. What shall happen if the **air supply** cut-off?

Considering that double-acting actuators won't move without air anyways, the combined spring-return makes usually only sense for single-acting actuators.

Valves with a combined-spring return offer a so-called **fail-safe function**.

The air spring offers in general various advantages:

- ✓ More equal switch-on and switch-off time over a wide pressure range.
- ✓ Lower minimum pressure possible
- ✓ No wear or breaking possible
- ✓ Cheaper
- ✓ No exhaust of end-cap necessary, therefore less dirt and moisture in the valve.

Combined spring (fail-safe)

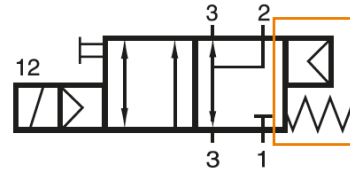

- Electricity cut: Valve closes by air / mechanic spring
- Air loss: Valve closes by mechanic spring

Air spring

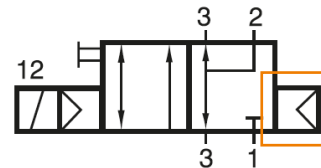

- Electricity cut: Valve closes by air spring
- Air loss: Valve remains open
Result: Spring-return actuator may not be able to exhaust / close under certain circumstances.

7. HAFNER offers different material options and surface treatments.



Valve body	Aluminum, anodized	Aluminum, EMATAL	1.4404 stainless steel
Pilot-head	Polyamide	Aluminum, EMATAL	1.4404 stainless steel
Spool	1.4104 stainless steel	1.4404 stainless steel	1.4404 stainless steel
Sealing system	Brass, NBR	1.4404 stainless steel, seals series 701: PUR, seals series 121: FKM	1.4404 stainless steel, seals series 701: PUR, seals series 121: FKM
Other inner parts	Brass, NBR, POM	1.4404 stainless steel, FPM, POM	1.4404 stainless steel, FPM, POM
Typical use	Standard applications, indoor	Applications with high demand for corrosion resistance due to salty sea-water	All kind of heavy duty applications like offshore, shipbuilding or oil- and gas

8. We can cover a temperature range from -50°C up to +120°C.

Standard Series

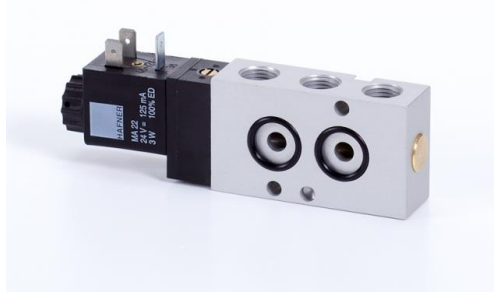

**“Hafner on the Rocks”
Low temperature valves**



High temperature valves



Temperature range	-10°C to +50°C / +60°C (optional -20°C)	-50°C	Electric valves: up to +80°C Non-electric: up to +120°C
Sealing material	NBR	PUR	FKM

Other temperature specifications available on request.

9. The HAFNER solenoid systems offer a superior protection in wet and humid environment.

MA 22



MA 22 D



MA 22 D M12



MND-series



Interface	Industrial form B	Industrial form B	M12	Form C
IP Class	IP 65 (with appropriate connector)	IP 67 (with appropriate connector)	IP 67 (with appropriate connector)	IP 65 (with appropriate connector)
Material	PA	Epoxy	Epoxy	PA
Power consumption	3.0 Watt	3.0 Watt	4,2 Watt	1.8 Watt
Other specs. and options	<ul style="list-style-type: none"> - UL-approval - Form B (DIN) - 2 Watt version 		With integrated LED	

10. Additional accessories protect the inside of the valve.

Silencers



Silencers protect the valve only to a certain degree from dirt and also moisture can still enter it.

Exhaust protection fittings for exhaust ports 3 and 5

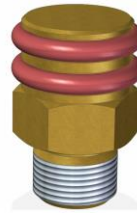

Exhaust protection fittings for pilot air exhaust.

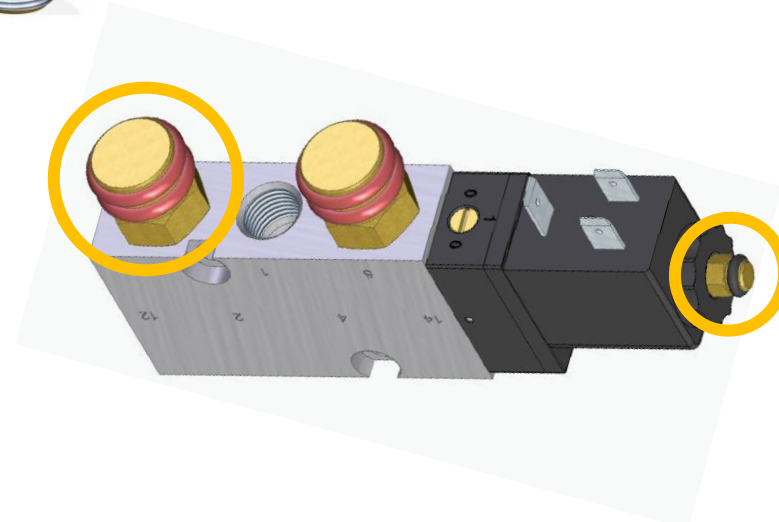

The Hafner exhaust protection fittings protect the exhaust ports from dirt and moisture. Prestressed O-rings cover the exhaust holes.

Please ask for our type „ESR“.

11. The NAMUR-interface is available in two sizes: NAMUR1 (1/4") and NAMUR2 (1/2").

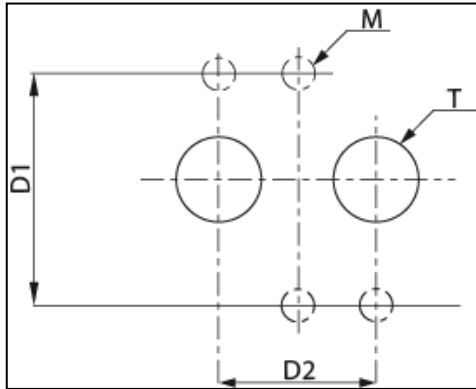

NAMUR-interface according to VDI/VDE 3845.

1/4 NAMUR-interface = NAMUR1



T	D1 (mm)	D2 (mm)	M (mm)
1/4 " (1/8")	32	24	M5
1/2 " (3/8")	45	40	M6

1/2 NAMUR-interface = NAMUR2



11. We offer three different series of NAMUR-valves.

Series 701

- Orifice size 7 mm
- NAMUR1
- Ports G 1/4"

1.250 l/min



Series 101

High-Flow Series

- Orifice size 10 mm
- NAMUR1
- Ports G 3/8"

2.250 l/min



Series 121

- Orifice size 12 mm
- NAMUR2
- Ports G 1/2"

3.000 l/min



12. We offer two different port configurations as this is not standardized according to NAMUR.

The port configuration in the actuators is not standardized.



Standard port-scheme
"701"

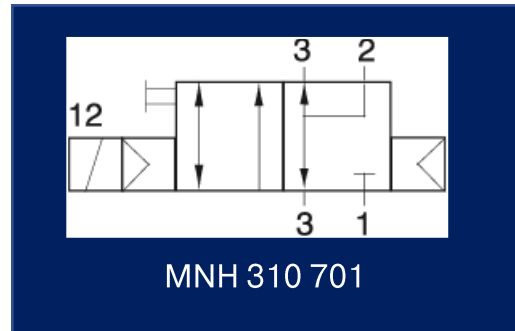

Alternative port-scheme
"711"

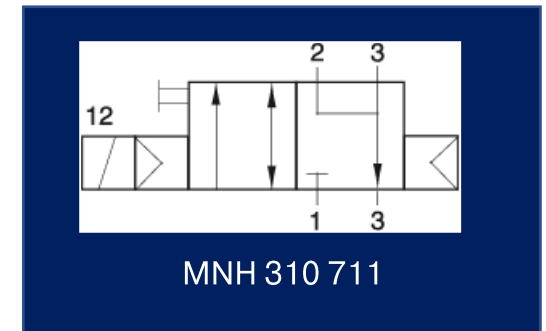

Target: Valve should be mounted with all ports facing downwards to avoid that dirt or water can enter the valve.

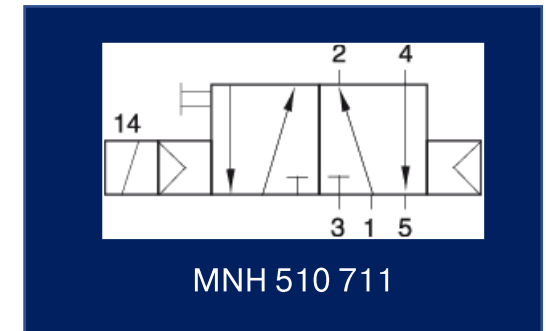
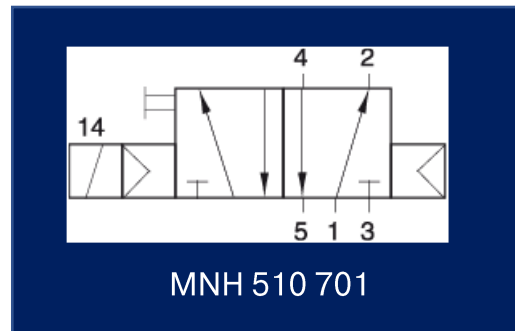





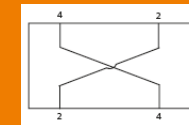

Accessory: ZPNX-16

The plate can be used to swap ports 2 and 4 of any NAMUR-valve with the 1/4-interface



13. The speed of the actuator / process valve has to be regulated by the pilot-valve or additional accessories.

Type	SVE ...	DRN ...	SGV 700	Series „101“	SENR ...	MNEH 611 611	ZPN 1/4-1/2	ZPN 6-10
Description	Flow control silencers	NAMUR flow regulator plates	2-speed valve	High-flow series	Quick exhaust block	Quick exhaust for positioners	Assembling plate NAMUR2 valve to NAMUR1 actuator	Assembling plate NAMUR1 valve to NAMUR 2 actuator
								
Function	Flow regulation	Flow regulation	Flow regulation	Quick-exhaust, quick opening	Quick-exhaust	Quick-exhaust	Quick-exhaust, quick opening	Flow reduction, cost-saving
Page	18	18	19	20	20	21	22	22

Further product information on the following slides.

13. The speed can be adjusted by flow control silencers or NAMUR flow regulator plates.

Flow control silencers

Type SVE...

- Opening- and closing speed adjustment for double acting actuators
- Cost-effective solution
- Only for applications with low demand for speed accuracy



Flow regulator plates

Type DRN...

- Opening- and closing speed adjustment for single- and double acting actuators
- Very precise regulation
- Only possibility to regulate the forward- and backward-stroke of a spring-return actuator, that is controlled by a 3-way valve separately and precisely
- Two different adjustment possibilities
- Also available with the 1/2 NAMUR-interface



Manual adjustment screw



Screwdriver adjustment

13. The HAFNER two-speed valve helps to avoid water hammers in the pipeline.

Two-speed valve Type SGV 700

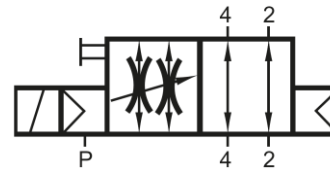

- Air streams through the valve without any restriction as long as the valve is switched-off.
- Valve switches to throttled-position as soon as an electric signal is applied.
- Smooth closing and opening of the process valve helps to avoid water hammers in the pipelines.

13. In order to open- or close an actuator with the 1/4"-interface at high speed, we recommend our 101-series or the quick-exhaust-blocks.

High-flow valves 101-Series

- Opens / closes with 2.250 NI/min
- Can be used as „quick-exhaust“ for double acting actuators



3/2-way, G 3/8"



5/2-way, G 3/8"

Quick-exhaust-blocks Type SENR...

- Exhausts with 2.500 l/min
- Non-return valve ensures, that no ambient atmosphere can be sucked into the actuator.
- Only for single-acting actuators

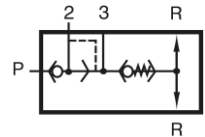

Version 1 (SENR 20):
For external piping G 1/4"



Version 2 (SENR 207):
For Hafner NAMUR-valves



Version 3 (SENR 207 01):
Combination of the two types above,
maximum flexibility:

- External piping possible
- NAMUR-valve mounting possible
- Use of larger coils (e.g. Ex-coils) possible

13. The quick-exhaust block is also available with NAMUR 2 interface.



Connection pilot-valve:
Interface actuator:
Flow rate pressurising:
Flow rate exhausting:

NAMUR 1 and G 1/4" threads
NAMUR 2
2.250 NI/min
5.300 NI/min

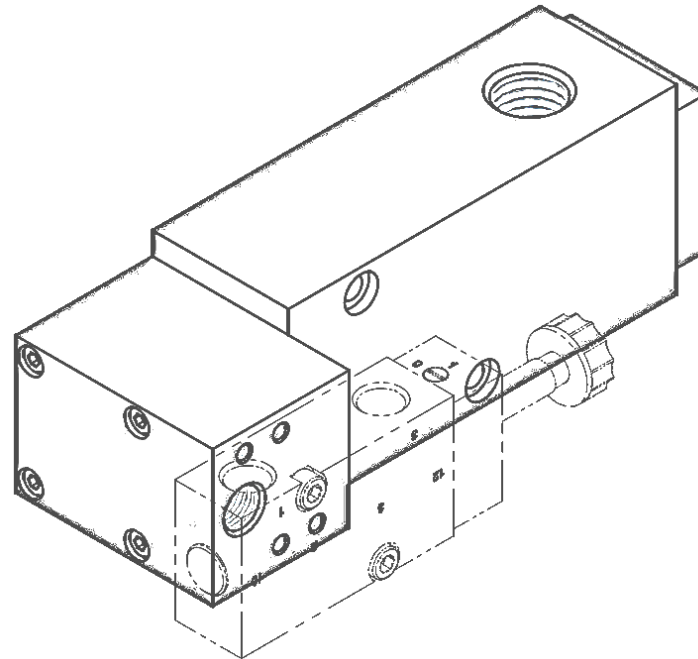

13. Quick-exhaust for positioners is a challenge, but possible with the HAFNER 6/2-way valves.

Quick-exhaust valve for positioners

- Air streams through the valve without any restriction as long as the valve is switched-on.
- As soon as electricity and/or air supply cut-off, depending on the type of actuation, the valve switches to the exhaust-position.
- The actuator will exhaust quickly through the valve instead of the small bores in the positioner.

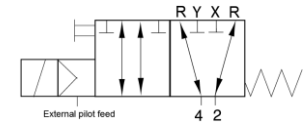

MNEH 611 611

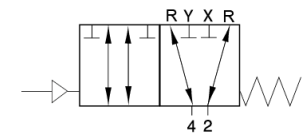

PN 611 611

Also available with adjustable actuating pressure:

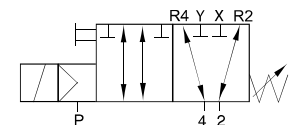
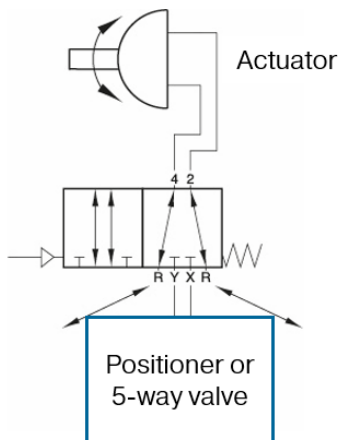

MNEH 611 611 SR 03

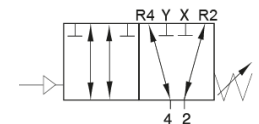

PN 611 611 SR 03

Also available with NAMUR 2 interface, type PN 611 121 SR 03

13. Two assembling plates can help to control the air-flow and realize cost-savings at the same time.

Assembling plate NAMUR1 valve to NAMUR2 actuator Type ZPN 6-10

- 7 mm bore restricts air-flow
- Use of 1/4" NAMUR-valve helps to reduce costs

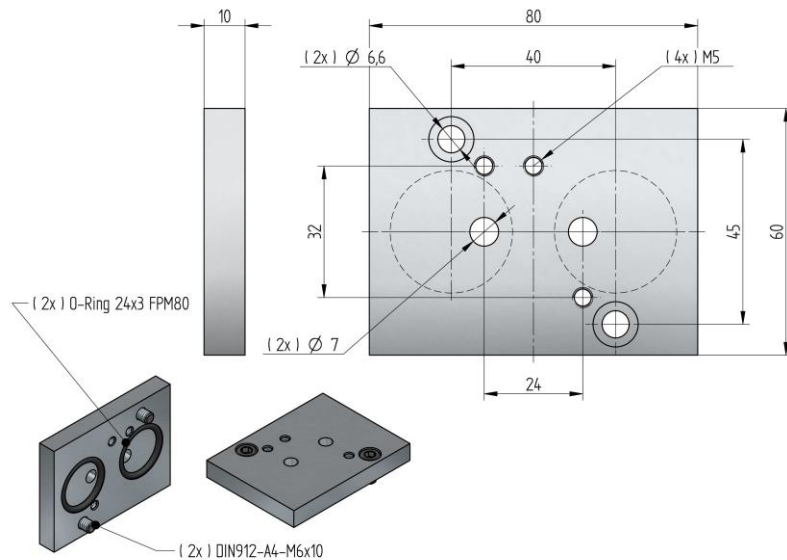

Small valve on big
actuator = slow down

Assembling plate NAMUR2 valve to NAMUR1 actuator Type ZPN 1/4-1/2

- Customers drilling up the bores in the actuator can realize faster movements
- Please note: the orifice size of the bores in the actuator restricts the air-flow.

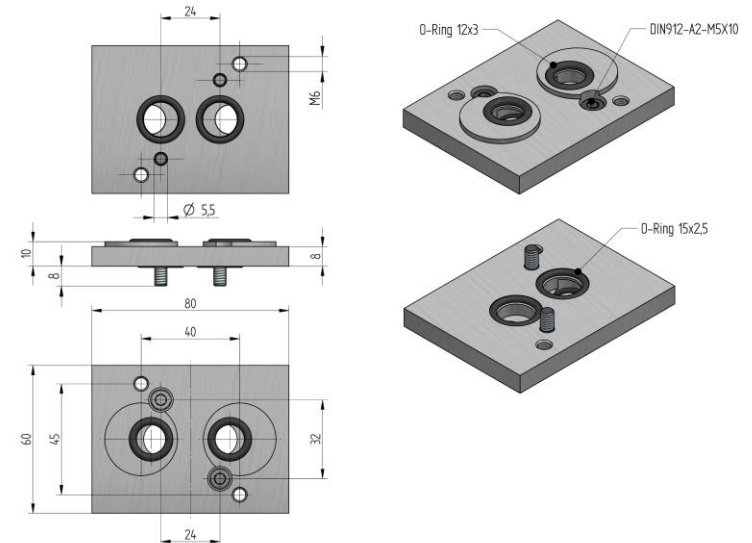

Big valve on small
actuator = speed up

13. For applications which need as much air-flow as possible, we have designed a 1/2" NAMUR-valve based on our 181-series.

1/2" NAMUR-interface based on the 181-series Type MNH ... 181

- Ports G 3/4"
- 6.000 NI/min
- 3/2-way and 5/2-way

Only available for projects / on request.

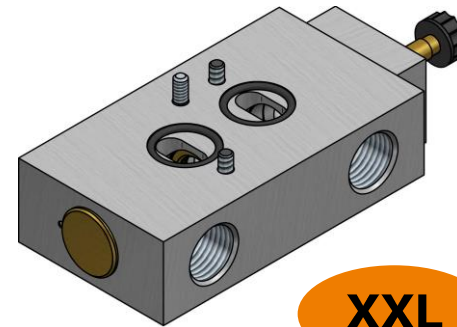
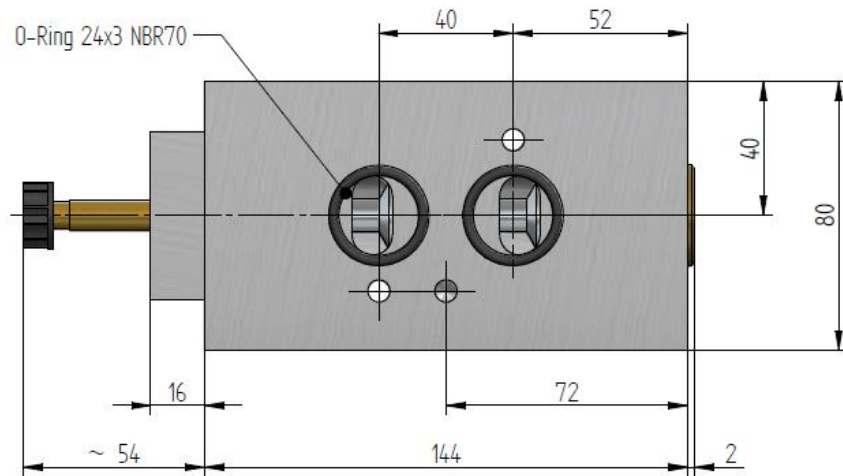

XXL

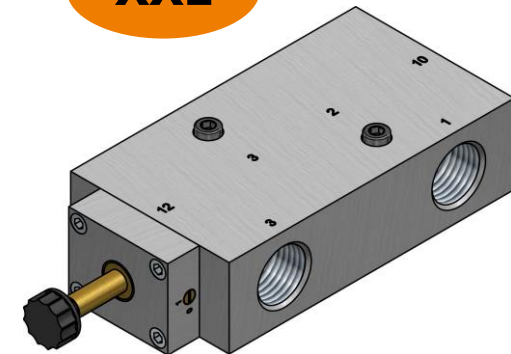

13. Concept for actuator manufacturers: small valve with interface similar to NAMUR, but different dimensions.

Valve based on MH-series (22 mm wide)

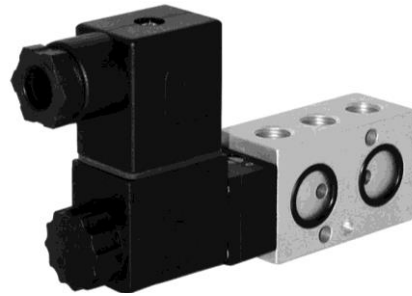

XS

Valve based on MD-series (16 mm wide)

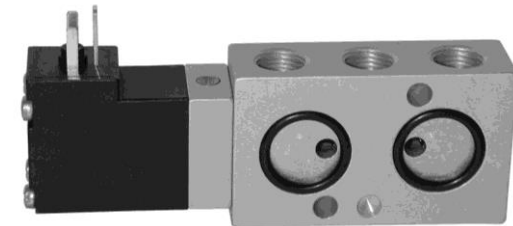

- Ports G 1/8"
- 450 NI/min
- Interface looks like NAMUR, but mounting holes are different (only 16 mm instead of 24 mm)

Only available for projects / on request.

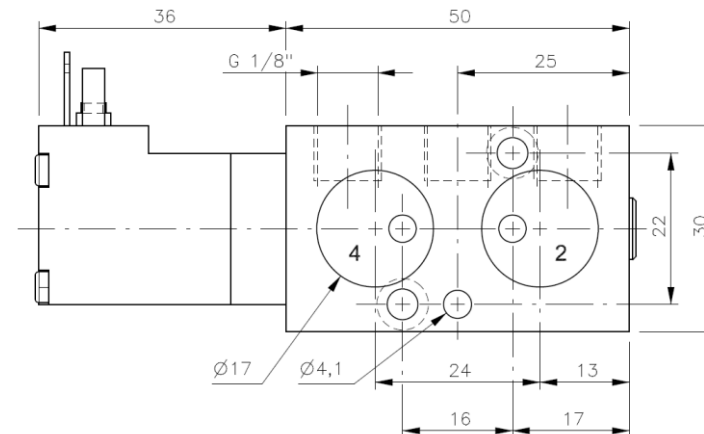

14. Explosion proof products are widely used in the process industry.

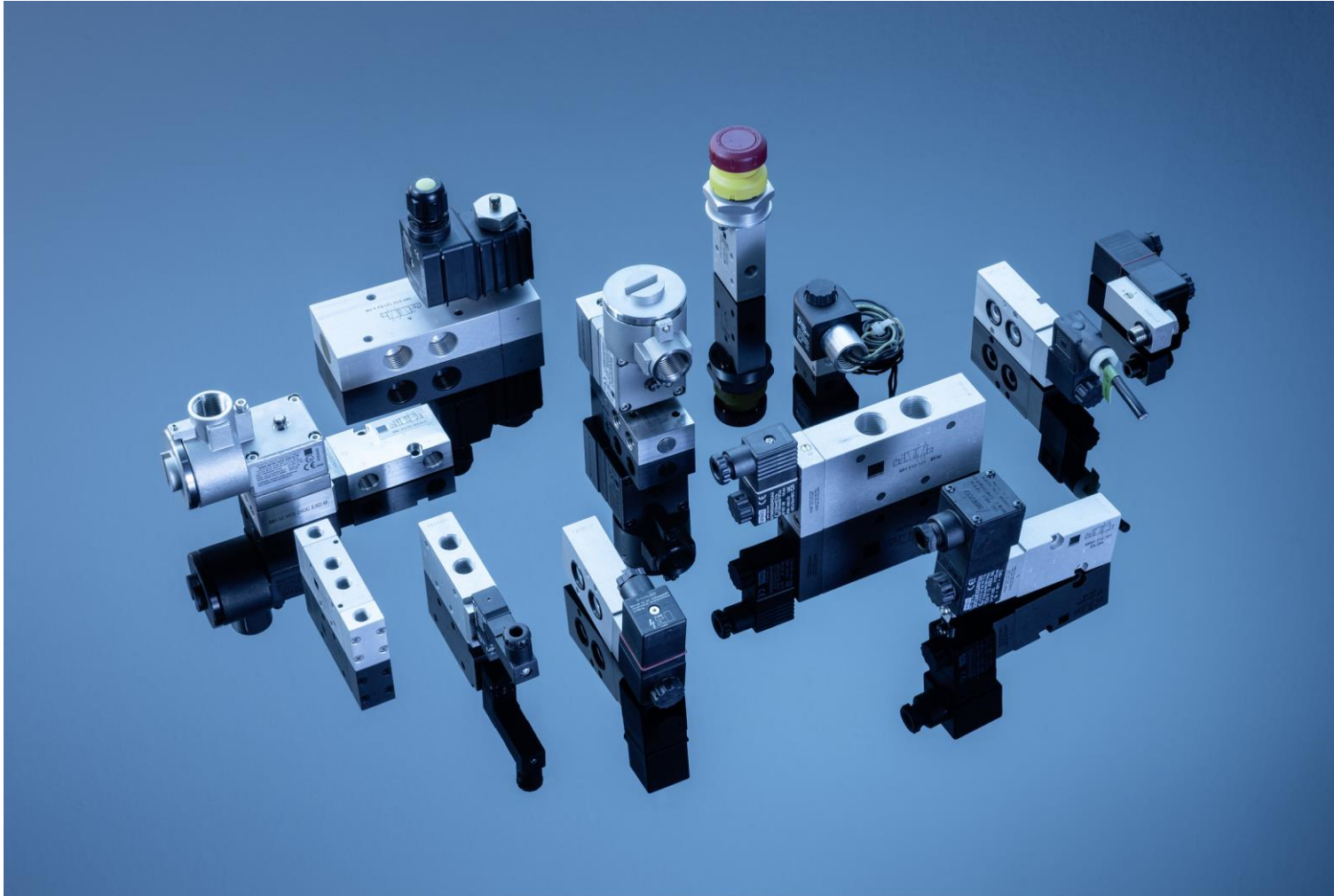

14. We offer a total of 8 different explosion proof coils with ignition protection from Ex nA up to Ex d.

Type of ignition protection		h (non-electrical)	Exec	Ex ia 1.6W	Ex ia 0.7W	Ex m	e mb	Ex dm	Ex d	Ex m CSA/FM
		Constructional safety	Increased safety	Intrinsically safe	Intrinsically safe, low power	Encapsulation	Increased safety / encapsulation	Encapsulation / flameproof	Flameproof	Encapsulation
										
Certificates	ATEX	✓	✓	✓	✓	✓	✓	✓	✓	
	IECEX			✓	✓	✓	✓		✓	
	CSA / FM									✓
	UKCA		✓							
	CCC			On request		On request			On request	
Zone	1G	✓		✓	✓	✓	✓	✓	✓	CSA Class I, Zone 1, Ex m II T4 Class I, Div. 1 & Div. 2, Gr. A, B, C, D Class II, Gr. E, F, G, Class III, T4
	2G	✓	✓	✓	✓	✓	✓	✓	✓	
	21D	✓		✓	✓	✓	✓	✓	✓	FM Class I, Zone 1, AEx m II T4 Class I, Div. 1 & Div. 2, Gr. A, B, C, D Class II, Gr. E, F, G, Class III, T4
	22D	✓	✓	✓	✓	✓	✓	✓	✓	
Temperature class		T6	T5 / T6	T6	T6	T4	T6	T5	T4 (AC) / T6 (DC)	T4
Explosion group		IIC / IIIC	IIC / IIIC	IIC / IIIC	IIC / IIIC	IIC / IIIC	IIC / IIIC	IIC / IIIC	IIC / IIIC	
Max. possible temperature range		-50°C to +50°C	-10°C to +50°C	-40°C to +50°C	-10°C to +50°C	-20°C to +50°C	-40°C to +50°C	-20°C to +50°C	-40°C to +50°C	-20°C to +60°C
Stainless steel version		✓	✓	✓		✓	✓	✓	✓	✓
Electrical connection			- T6: Plug for 4-8 mm cable - T5: Plug for 6-8 mm cable	Plug for 6-8 mm cable	Plug for 3.5 – 6 mm cable	3 metre moulded cable, 10 metres on request	M20x1,5 6 – 13 mm	M20x1,5 6 – 8 mm	M20x1,5 or 1/2" NPT Cable gland not included	30 cm strands
Power consumption			- T6: 2 Watts - T5: 3 Watts	1.6 Watts	0.7 Watts	5.0 Watts	4.8 Watts	3.0 Watts	2.0 Watts	4.6 Watts
IP protection class			IP 65	IP 65	IP 65	IP 65	IP 65 (IP 67 optional)	IP 65	IP 67	IP 65

15. Many valves are also SIL III certified according to IEC 61508:2010.



The manufacturer may use the mark:



Revision 2.0 Jan 9, 2020
Surveillance Audit Due Feb 1, 2023



ISO/IEC 17065
PRODUCT CERTIFICATION BODY
#1004

**Certificate / Certificat
Zertifikat / 合格証**

HAF 1511126 P0038 C001

exida hereby confirms that the:

**Mechanically actuated valves
Direct operated solenoid valves
Pneumatically operated valves
Pilot operated solenoid valves**

**HAFNER Pneumatika Kft.
Halászi, Hungary**

Have been assessed per the relevant requirements of:
IEC 61508 : 2010 Parts 1-7
and meets requirements providing a level of integrity to:
**Systematic Capability: SC 3 (SIL 3 Capable)
Random Capability: Type A, Route 2_H Device
PFD_{AVG} and Architecture Constraints
must be verified for each application**

Safety Function:
The valve will move to the designed safe position when de-energized / energized within the specified safety time.

Application Restrictions:
The valve must be properly designed into a Safety Instrumented Function per the Safety Manual requirements.



Peter F.
Evaluating Assessor

Steven J. Chase
Certifying Assessor

Page 1 of 2



80 N Main St
Sellersville, PA 18060

T-100, V1R2

Certificate / Certificat / Zertifikat / 合格証

BAC 1511126 P0038 C001

**Systematic Capability: SC 3 (SIL 3 Capable)
Random Capability: Type A, Route 2_H Device
PFD_{AVG} and Architecture Constraints
must be verified for each application**

Systematic Capability :
The products have met manufacturer design process requirements of Safety Integrity Level (SIL) 3. These are intended to achieve sufficient integrity against systematic errors of design by the manufacturer.
A Safety Instrumented Function (SIF) designed with these products must not be used at a SIL level higher than stated.

Random Capability:
The SIL limit imposed by the Architectural Constraints must be met for each element. These devices meets exida criteria for Route 2_H

IEC 61508 Failure Rates:
The failure rates for the assessed valves are found in the document:
HAFNER 1511-126-C Annex to certificate R004 V2 R0.

SIL Verification:
The Safety Integrity Level (SIL) of an entire Safety Instrumented Function (SIF) must be verified via a calculation of PFD_{AVG} considering redundant architectures, proof test interval, proof test effectiveness, any automatic diagnostics, average repair time and the specific failure rates of all products included in the SIF. Each element must be checked to assure compliance with minimum hardware fault tolerance (HFT) requirements.

The following documents are a mandatory part of certification:
Assessment Report: HAFNER 15/11-126-C R003 Assessment report V2 R0
Safety Manual : HAFNER Safety Manual V1 R1

Page 2 of 2

16. Valves with position feedback sensor give a signal to the PLC that the valve has fully switched through.

- Sensor gives feedback if valve has switched
- Higher safety, can be important for SIL rating
- Valves with Balluff sensor and 0.30 meter cable
- Valves with Contrinex sensor according to NAMUR (DIN 19234)



17. We offer various options for the fail-in-place / stay-put function.

DSVN-5

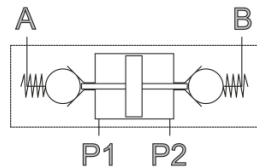

- Valve blocks actuator in case the pressure cut off
- Air-flow limited to 230 l/min
- Combination with 5-way valves only

PN 411 711

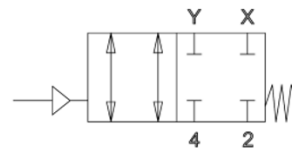

- Pressure applied = normal operation
- If pressure cut off, the valve will block all ports = „stay-put“ / „fail-in-place“
- Air-flow of 1.250 l/min

MNEH 411 711

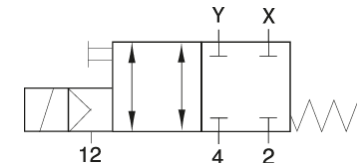

- Electric signal & pressure applied = normal operation
- If any of both cut off, the valve will block all ports = „stay-put“ / „fail-in-place“
- Air-flow of 1.250 l/min

17. Pneumatic pressure switches offer an adjustable knob for defining the lock-up pressure.

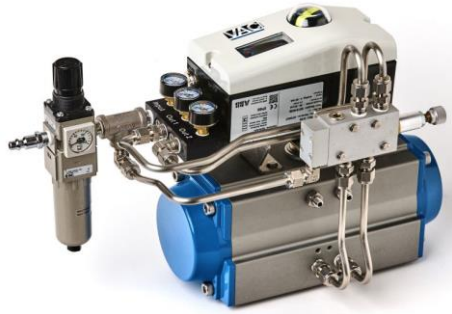

For single acting actuators

P 311 501 SR

For double acting actuators

P 411 701 SR

- The actuating pressure can be adjusted between 3 – 8 bar depending on the valve type
- Hysteresis of around 1.5 bar has to be taken into consideration
- Port size G 1/8, G 1/4, or 1/4 NPT

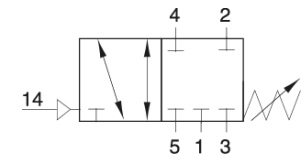
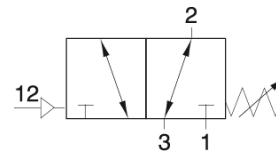

Flange type with base-plate for direct assemblage to positioners available on request.

17. Customers use the lock-up valves often in combination with positioners.

For single acting actuators

P 311 501 SR

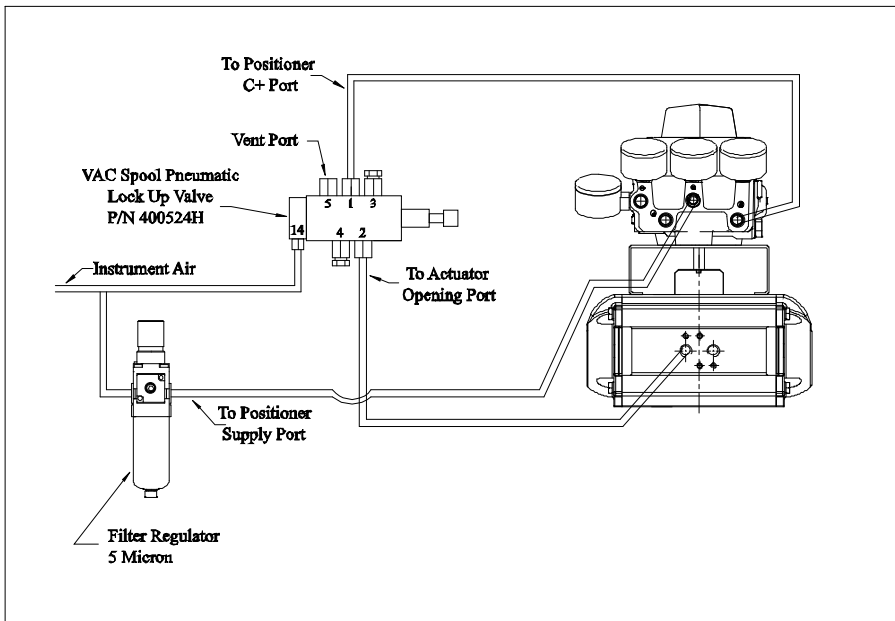

For double acting actuators

P 411 701 SR

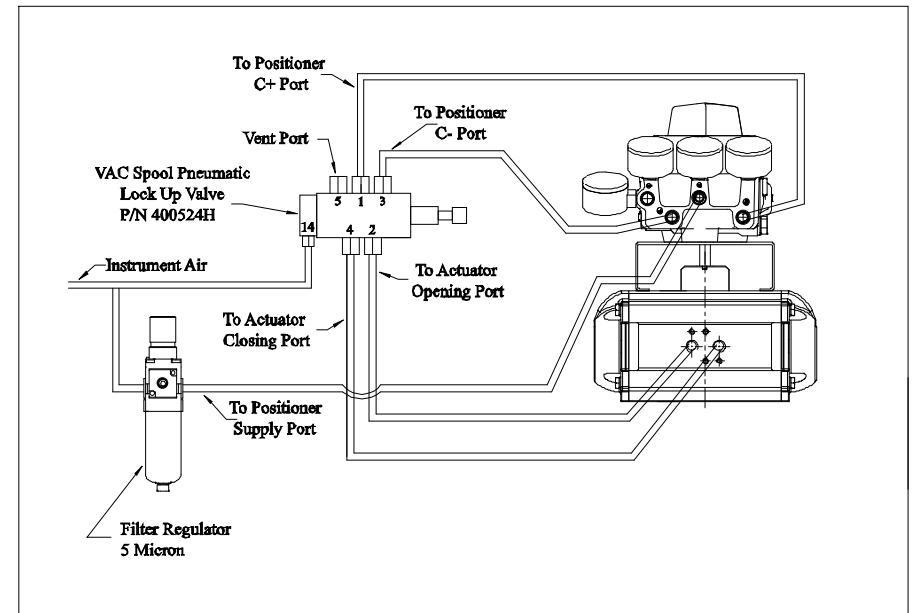

18. Apart from the fail-in-place function, customers also ask for fail-exhaust.

Redundancy block Type SRB 700

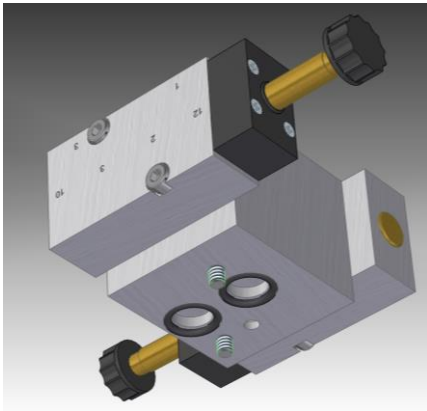

- Control block for single-acting actuators
- Both 3/2-way valves have to be electrically actuated to pressurize the actuator
- If one of the two valves fail, the block will exhaust the actuator and the actuator can close by the force of its spring.

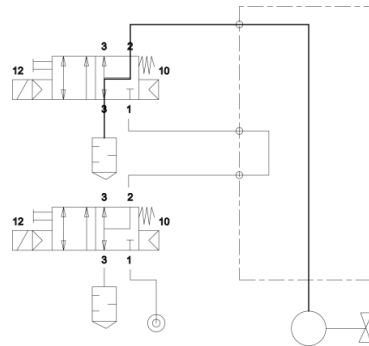

Both valves not actuated

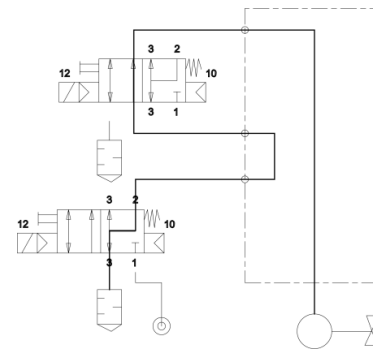

First valve actuated,
second valve not actuated

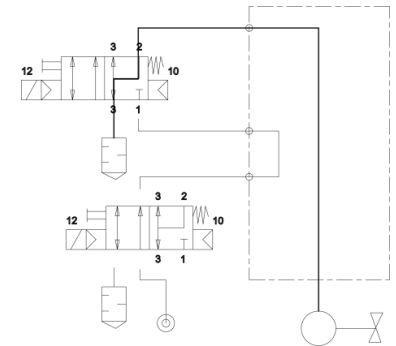

First valve not actuated,
second valve actuated

18. The 6/2-way valves from page 19 can be used for various control tasks including fail-exhaust.

Pneumatic actuation

PN 611 611

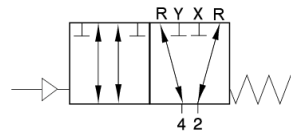

Solenoid valve with external pilot feed

MNEH 611 611

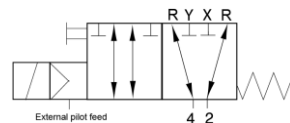
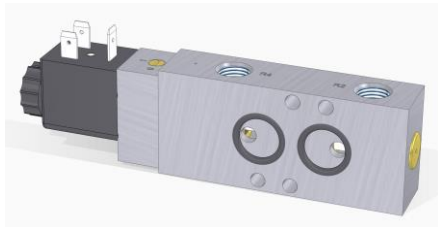

Venting of the actuator chambers (fail-exhaust)

As soon as the valve is switching its position, the actuator will be exhausted and close by its springs. If there is a gearbox, it can be operated without working against trapped air.

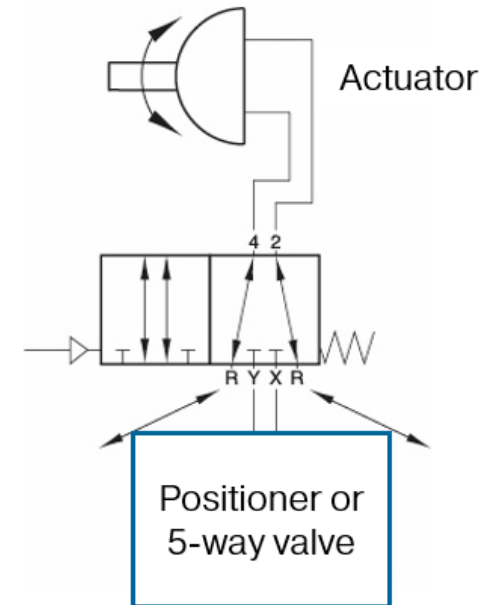

19. Also fail-open / close of double acting actuators is possible.

Pneumatic actuation

PN 611 611

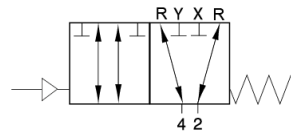

Solenoid valve with external pilot feed

MNEH 611 611

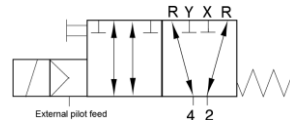
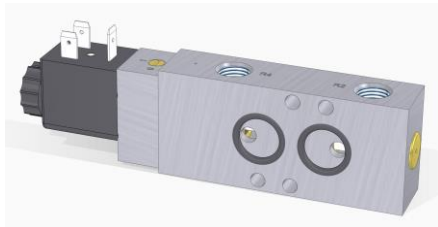

Pressurisation of the actuator chambers

With the additional volume from an external air-tank, even a double acting actuator can be opened or closed in fail-safe cases.

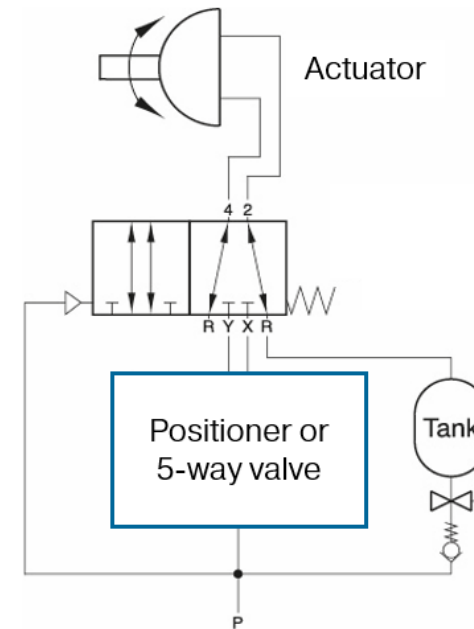

20. These valves can be also used as a switch to select from two different air sources.

Pneumatic actuation

PN 611 611

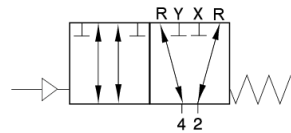

Solenoid valve with external pilot feed

MNEH 611 611

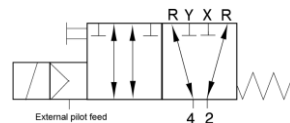
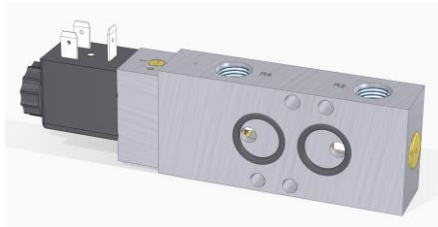

Selection between two valves / sources

Valve can be used to select from two different pilot valves or other sources (e.g. to realize redundant circuits).

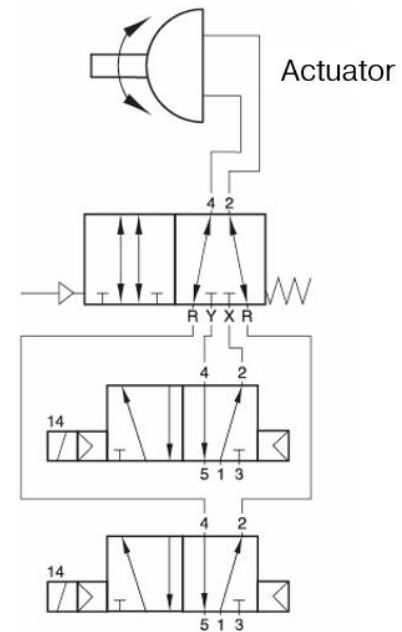

21. With our manual **block- and vent** valves the user can **exhaust** the air from the actuator.



BHN 601

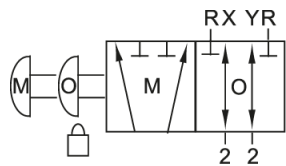

- Exhausts actuator when operated
- Lockable in **automatic** position



BHN 601 01

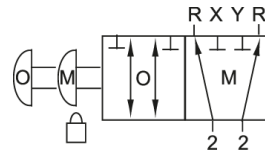

- Exhausts actuator when operated
- With protection pin for the automatic position "O"
- Lockable in **maintenance** position



BHN 601 02

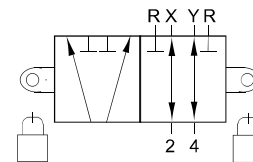

- Exhausts actuator when operated (without knob)
- Lockable in **both** positions



BHN 601 01 LL EA

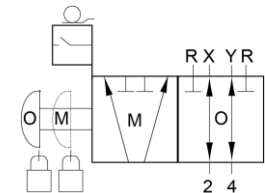

- Exhausts actuator when operated
- Lockable in **both** positions
- With position feedback sensor

Typical application: Maintenance of process valves

21. With our manual **block- and block** valves the user can **block** the air in the actuator.



BHN 611 01

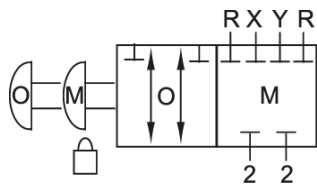

- Blocks actuator when operated
- With protection pin for the automatic position "O"
- Lockable in maintenance position



BHN 611 02

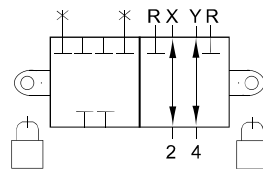

- Blocks actuator when operated (without knob)
- Lockable in **both** positions



BHN 611 01 LL EA

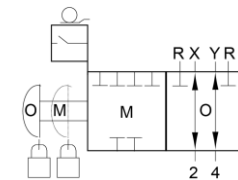

- Blocks actuator when operated
- Lockable in **both** positions
- With position feedback sensor

Typical applications:

- Cleaning of tanks
- Repair works in the pipeline

22. Process valves equipped with a manual gearbox have to be vented in case of manual operation.



- No damage of the actuator
- Operator doesn't have to work against trapped air
- No ambient atmosphere can be sucked into the actuator
- Valves can be put between NAMUR pilot-valve and actuator or direct piped (G 1/4")

BHN 420 701

Manually actuated

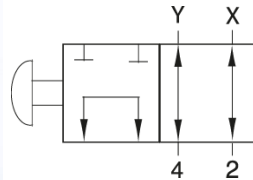

PN 411 701

Pneumatically actuated

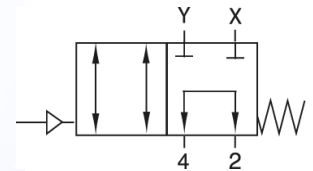

23. With the pneumo-manual override valves from HAFNER a positioner can be manually overrode by the help of external air supply. These valves are also equipped with a safety lever.

HVRZN 731 701

5/2-way

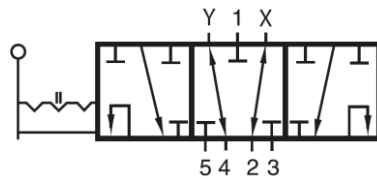

HVRZN 731 702

5/3-way

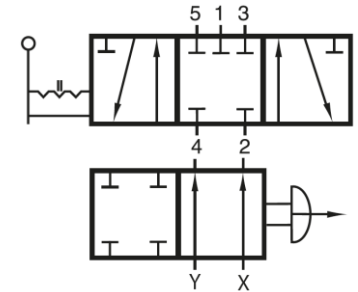

How it works:

- 1 Separate air-supply
- Y+X Air coming from the positioner
- 4+2 Air going to the actuator

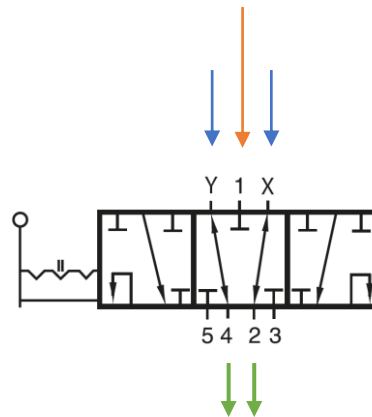

24. For butterfly valves with an inflatable valve-seat we offer a control block to move the actuator as well as inflate- and deflate the seal.



- Control block for butterfly valves with inflatable seal
- Block is to be put between 5/2-way NAMUR pilot-valve and actuator
- The time delay can be adjusted between 0 and 2 seconds at 6 bar

CBN 700 K
Standard type

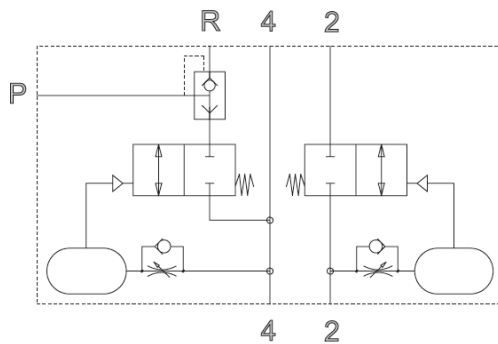

CBN 700 K EB
With additional position feedback port

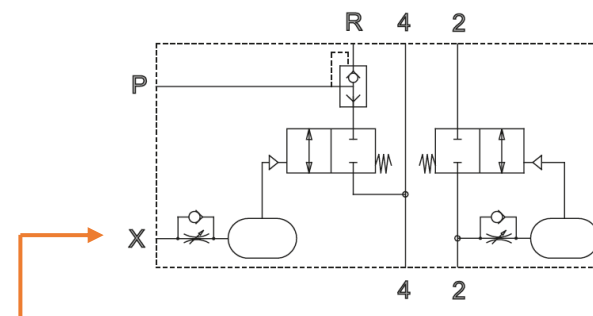

Type CBN 700 K EB with additional port X:
pressurizing of the inflatable seal does not start
before a pneumatic signal is received.

24. For butterfly valves with an inflatable valve-seat we offer a control block to move the actuator as well as inflate- and deflate the seal.

The CBN is also available for
single-acting actuators



CBE 700 K
Standard type

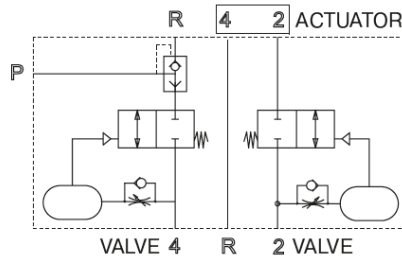

CBE 700 K EB
With additional position feedback port

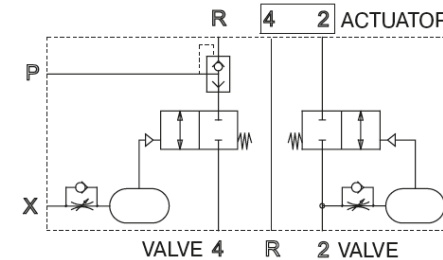

Please note: The block only works on spring-close applications

25. Valves with latch-lock function can be switched-on electrically and switched-off manually.

**Latch-lock valves
Type MNOHH 320 701**

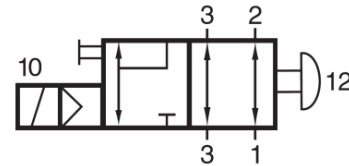

1. Switching-on with the solenoid
2. Switching-off manually

Typical application: Fire safety systems

In case of fire alarm → electric signal applied to the MNOHH

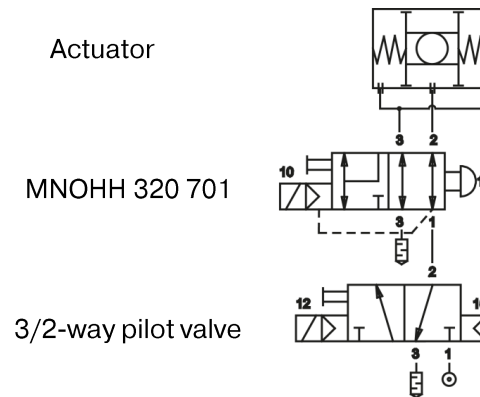

26. Valves with manual reset function can be used for monitored reactivation by maintenance staff.

Manual reset button valves

Type MHL ...

In order to operate the valve, the knob must be pushed after energizing the solenoid coil.



1. Valve switches with electric signal and by pushing the knob
2. Valves closes as soon as electric signal cut off
3. In case electric signal comes back, valve remains closed
4. Maintenance personal has to manually reset it

27. Various mounting accessories make our customers life easier.

Distance plates (e.g. for larger Ex-coils)



ZPN 5

- 5 mm distance plate
- 1/4" NAMUR-interface

ZPN 8

- 8 mm distance plate
- 1/4" NAMUR-interface

ZPN 6-5

- 5 mm distance plate
- 1/2" NAMUR-interface

Plate to assemble a 1/4" NAMUR- valve to 1/2" actuator



ZPN 6-10

- Cost effective solution if the air-flow of a 1/4" NAMUR-valve is sufficient

Plate to assemble a 1/2" NAMUR- valve to 1/4" actuator

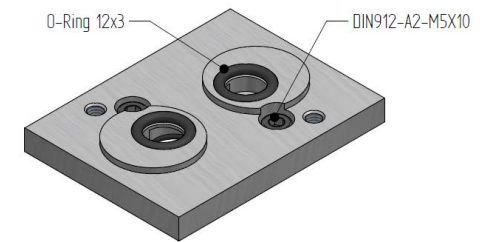

ZPN 1/4-1/2

- Customers drilling up the bores in the actuator can realize faster movements
- Please note: the orifice size of the bores in the actuator restrict the air-flow.

27. Various mounting accessories make our customers life easier.

Threaded plate to allow external piping to our NAMUR-accessories



GPN 1/4

- Plate to convert a 1/4" NAMUR-interface into 2 x G 1/4" threaded ports for remote piloting.
- For 1/2" NAMUR-interface on request.

Assembly plate NAMUR - INLINE



FPNW 22-1/4

- Plate to convert a 5-way NAMUR-valve into an inline valve.
- The NAMUR ports 2 and 4 are transferred into the plate and offer G 1/4" threads.
- Mounting plate can be assembled independently and the valve is attached later-on.

FPNW 30-1/2

- Wit NAMUR 2 interface and G 1/2" threads

Assembly plate NAMUR - ISO

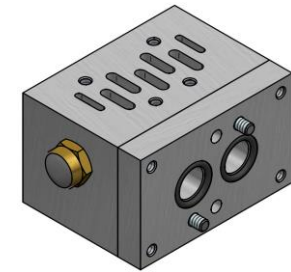

APN ISO T1

- Assembly plate to mount an ISO1 valve according to ISO 5599-1 to an actuator with NAMUR-interface.

27. Various mounting accessories make our customers life easier.

Plate so swap ports 2+4

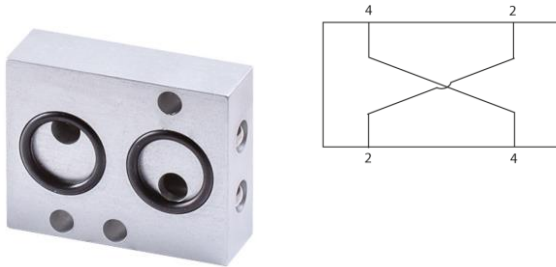

ZPNX 16

- Plate to swap the working ports of a NAMUR-valve
- Can be used in case pressure- and exhaust ports face into the wrong direction

Plate to turn the NAMUR-interface by 90°



ZPN 701-90

- Some actuators have a vertical NAMUR-interface mounting pattern for which our plate can be useful

Plates with additional threaded ports

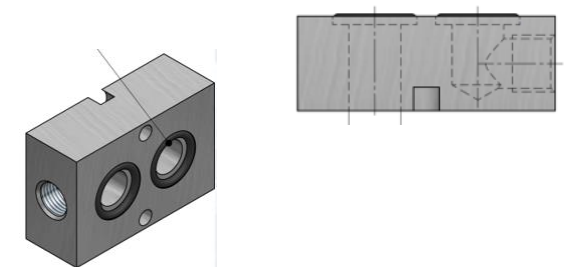

ZGPN-3-1/4

- 1/4" NAMUR-interface
- Exhaust air from the actuator is not going back to the valve, but has an additional G 1/4" threaded port

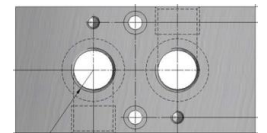

ZGPN-1/2

- 1/2" NAMUR-interface
- Both bores have an additional G 1/2" threaded port.

28. Cylinder-valve-combination plates allow the assemblage of NAMUR-valves to linear and scotch-yoke actuators.

ZVP

For linear actuators

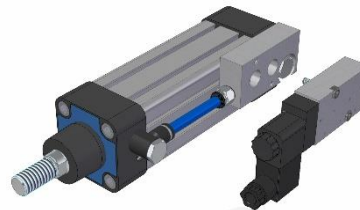
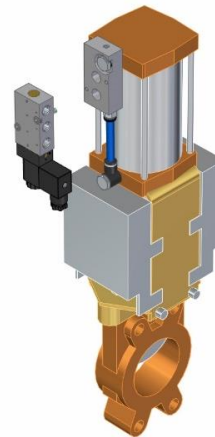

ZVPS

For scotch-yoke actuators

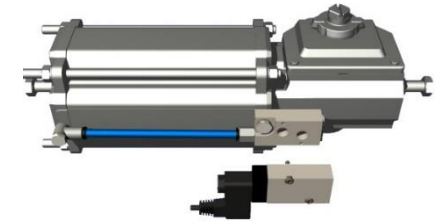

Advantages:

- ✓ Minimal air consumption
- ✓ Fast response
- ✓ Easy set-up
- ✓ Maintenance friendly
- ✓ Modular

29. The linear actuators of the „LAZ“ series are ideal for the automation of knife gate valves.



General information:

- Double acting
- Integrated cushioning rings
- Magnetic piston as standard feature
- Piston diameter from 80 mm to 320 mm
- Actuators with piston diameter 80 - 160 mm with interface to the pilot valve according to VDI/VDE 3845 (NAMUR 1 - 1/4“)
- Actuators with piston diameter 200 - 320 mm with interface to the pilot valve according to NAMUR 2 - 1/2“

The LAZ actuators have been developed for the paper industry. They are therefore extremely robust and can be used in challenging applications such as junk traps.



HAFNER Pneumatik Krämer GmbH & Co. KG
Stammheimer Straße 10

D-70806 Kornwestheim

Phone +49 – 7154 – 17 85 89 0
Fax +49 – 7154 – 17 85 89 28

info@hafner-pneumatik.de
www.hafner-pneumatik.de

Hafner Pneumatika Kft.
Püski út 3.

H-9228 Halászi

Phone +36 – 96 – 57 30 12
Fax +36 – 96 – 21 06 15

ertekesites@hafner-pneumatika.com
www.hafner-pneumatika.com