

All contents of this presentation, in particular text, photographs and graphics, are copyright-protected. Please ask us if you would like to use the content of this presentation. Use, even in excerpts, only with the express consent of Hafner-Pneumatik Krämer GmbH & Co. KG.

Content:

1. [What is explosion protection?](#)
2. [How do I ensure explosion protection?](#)
3. [Global explosion norms and standards](#)
4. [When does a product fall under the ATEX directive?](#)
5. [Differentiation between electrical and non-electrical devices in the ATEX directive](#)
6. [Electrical and non-electrical devices are identified using the same scheme](#)
7. [Example marking of ATEX components](#)
8. [Meaning of the individual elements of the ATEX marking:](#)
 - a. [Product group](#)
 - b. [Equipment category / zone](#)
 - c. [Ignition protection type](#)
 - d. [Explosion group](#)
 - e. [Temperature class](#)
9. [Selection of explosion-protected valves with different types of ignition protection](#)
10. [Product selection tree to find the Ex-valve which meets your needs](#)
11. [Explosion-proof valves with a SIL3 certificate](#)
12. [Antistatic compressed air hoses](#)
13. [Fittings are not covered by the ATEX directive](#)
14. [Air treatment units are generally not covered by the ATEX directive](#)

Explosion protection

What is explosion protection?



Explosion protection is a field of technology that deals with protection before explosions arise and that manages their effects. When dealing with substances that could react with air or oxygen, an explosion hazard must always be addressed if the combustible substance is present in a room with a particular Partial pressure or as a fine-grain dust in the air.

A **hazardous explosive atmosphere** (explosive gas-air mix) is present if the proportion of the combustible gas or a vaporised liquid lies between **the lower explosion limit (LEL) and the upper explosion limit (UEL)**. In the case of dusts, the size of the dust grains must adequately small and a minimum density must be present for an explosive atmosphere to exist.

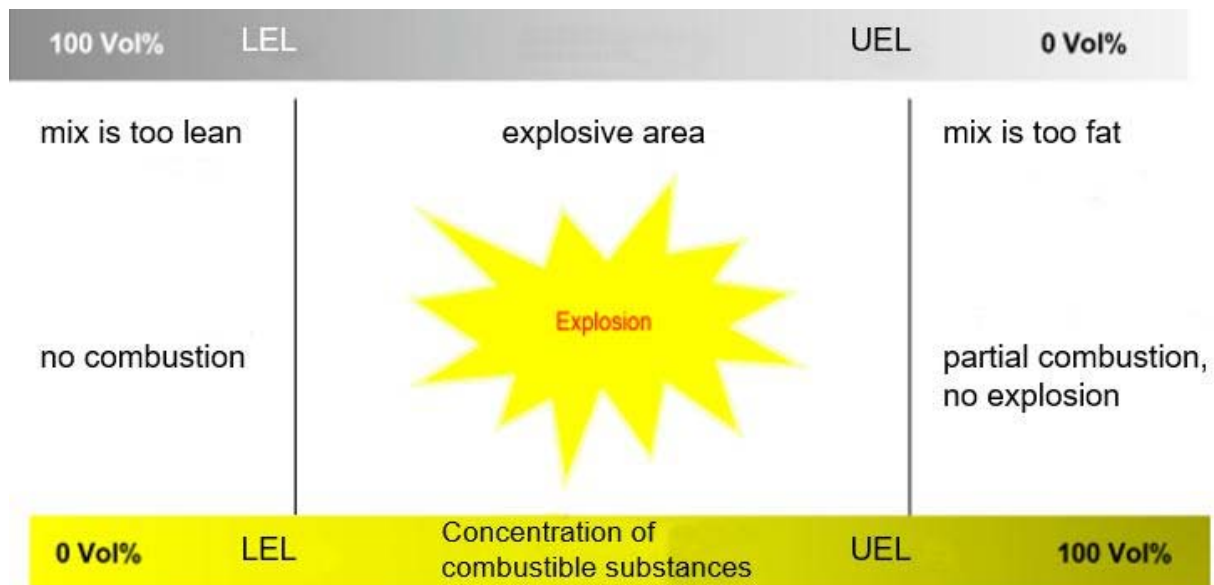

Chapter 16:

Explosion protection

The following diagram can assist in obtaining an initial overview of whether explosion protection measures may be necessary.

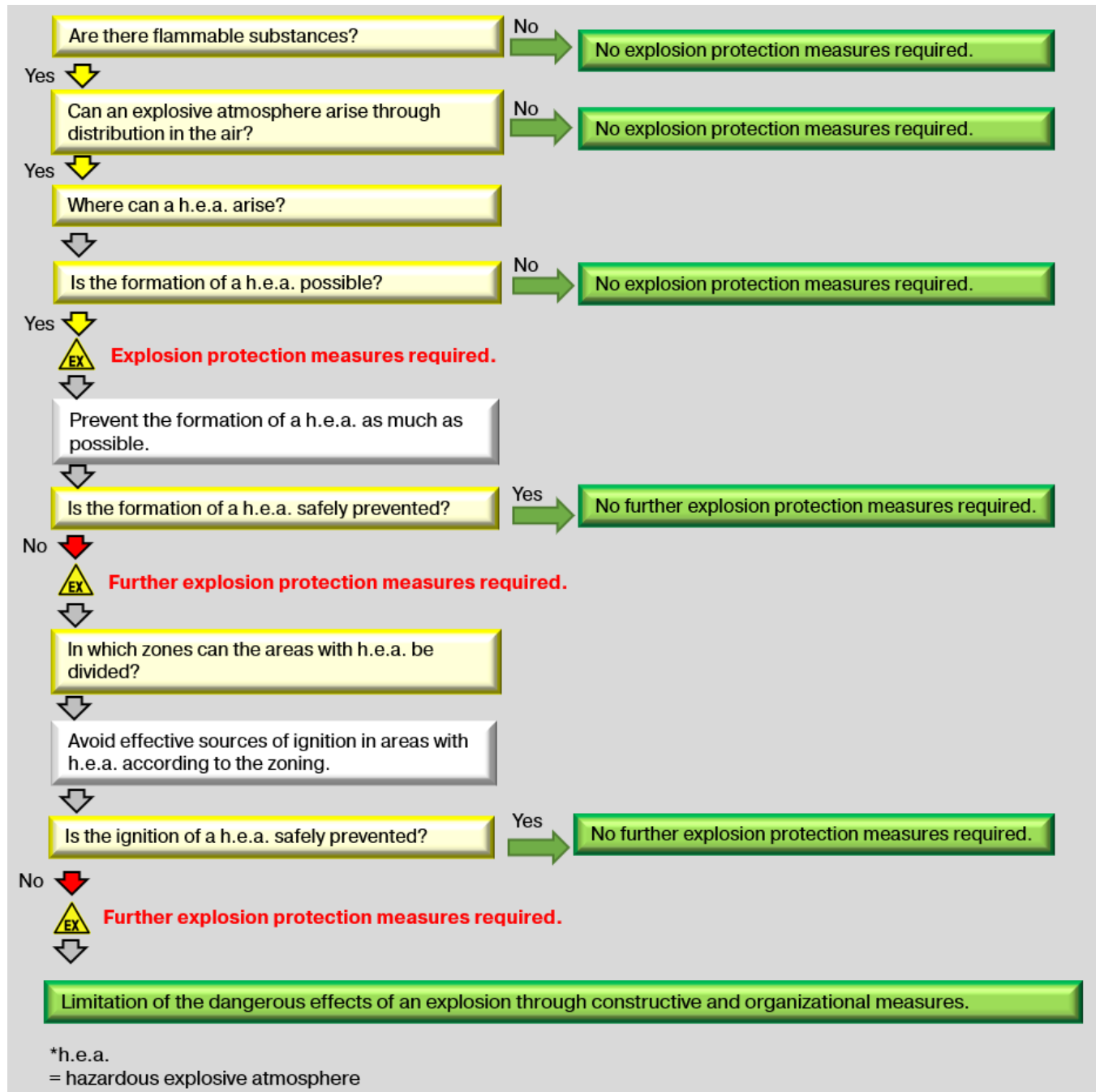

Source: Wikipedia

Explosion protection

The **limit oxygen concentration (LOC)** is the maximum concentration of oxygen in a mixture of a combustible substance with air and inert gas whereby an explosion will not occur. Along with the upper and lower explosion limits and the flashpoint, the oxygen concentration is an important characteristic value of an explosive mixture.

Inert gases are gases that are very slow to react (inert) and so take part in only a few chemical reactions. Inert gases include, for example, elementary gases such as nitrogen, noble gases such as helium, neon, argon, krypton, xenon, and gaseous molecular compounds such as sulphur hexafluoride.

The **flashpoint** is the lowest temperature at which, with the test conditions stipulated, a liquid releases flammable gas or flammable vapour in sufficient quantities that a flame appears immediately upon contact with an ignition source.

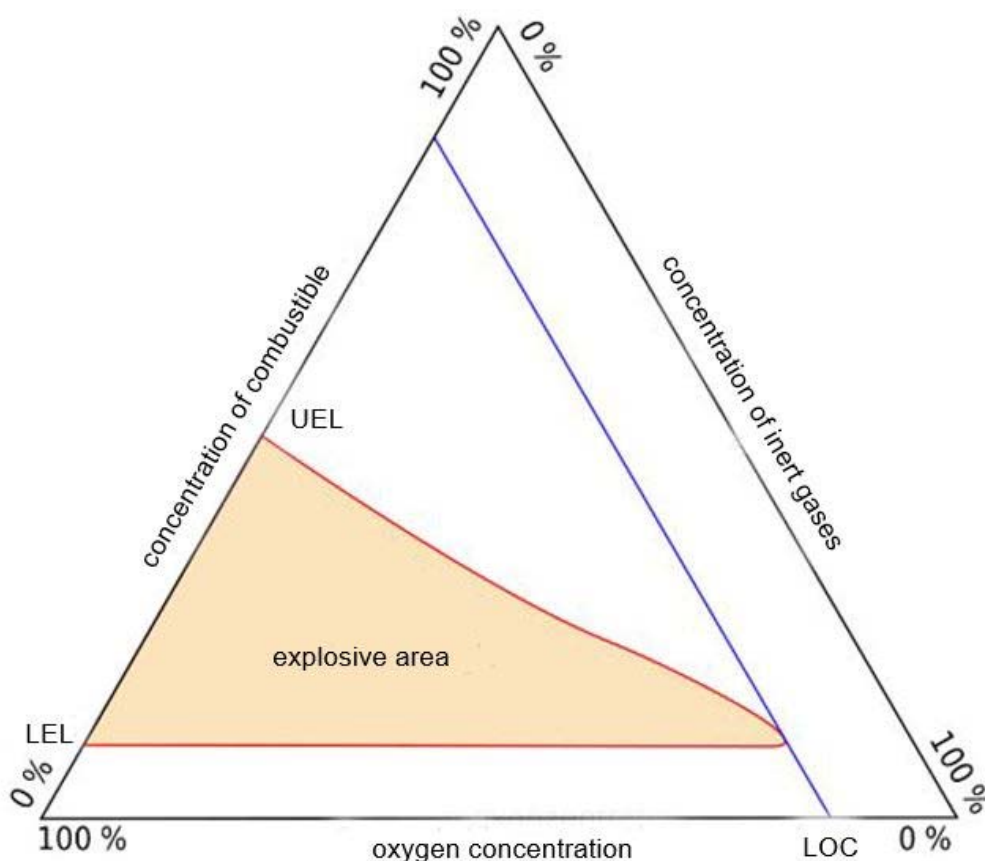

How do I ensure explosion protection?

Explosion protection is achieved through the implementation of "integrated explosion safety" by means of **primary**, **secondary** and **tertiary** protective goals.

Primary explosion protection	Measures which prevent or restrict the formation of hazardous explosive atmospheres. → Prevention of explosive atmospheres
Secondary explosion protection	Measures which prevent the ignition of hazardous explosive atmospheres. → Avoidance of effective ignition sources
Tertiary explosion protection	Measures which limit the effects of an explosion to a harmless level. → Design explosion protection

Primary explosion protection should initially be implemented. If this is not possible to an adequate extent, secondary and tertiary explosion protection must be implemented. This is where explosion-protected devices, as dealt with in the following section, come into play.

Chapter 16:

Explosion protection



Which global explosion norms and standards are relevant?

The complex, internationally valid requirements for the use of components in potentially explosive applications are laid down in the most important directives and standards for the world market:

- IECEx (International)
- ATEX Directive 2014/34/EU (Europe)
- NEC500/505 e.g. UL, FM, CSA (North America)
- CCC Ex (China)
- KCs Ex (Korea)
- EAC Ex (Russia)
- INMETRO (Brazil)
- TIIS (Japan)
- UKCA (United Kingdom)
- PESO (India)

A large number of Hafner products meet the requirements defined for equipment for use in potentially explosive areas. In contrast to the internationally recognised IECEx regulations or the North American regulations (HazLoc-NA®), the EU directive ATEX 2014/34/EU also includes non-electrical equipment in the explosion protection.



Explosion proof products

HAFNER offers products according to IECEx, ATEX, NEC500/505 (CSA/FM), UKCA and CCC.

■  **HazLoc-NA[®]**

■  **ATEX**

■ **Ex EAC**

■  **IECEx**

■ China und Indien akzeptieren die Richtlinie 94/9/EG (ATEX)

Chapter 16:

Explosion protection

When does a product fall under the ATEX directive?

The regulations relevant for the European market are found in the ATEX 2014/34/EU directive. This also defines when a product falls under the directive.

What are devices in the context of the directive?

- ✓ Machines, equipment, stationary and mobile devices, control and equipping parts, as well as warning and equipping systems, which individually or in combination generate, transmit, store, measure, control, convert or consume energy or are intended for the processing of materials and which have their own potential ignition sources and can therefore cause an explosion.

A device is subject to the directive if

- ✓ device in the sense of the directive + inherent potential ignition source



A device is not subject to the Directive if

- ✓ **not a device** in the sense of the directive + inherent potential ignition source



- ✓ device in the sense of the directive + **no inherent** potential ignition source

Chapter 16:

Explosion protection



Differentiation is made between electrical and non-electrical devices in the ATEX directive.

The approach for non-electrical devices differs from the conformity assessment procedure for electrical devices per ATEX 2014/34/EU. The vast majority of non-electrical devices are covered by a **self-declaration by the device manufacturer**.

Electrical devices on the other hand must usually be certified by a notified body. The respective certification process required depends on the device category.

Overview:

Approvals process	Device category 3	Device category 2	Device category 1
Non-electrical device	Self-declaration	Self-declaration + submission of documentation to a notified body	Testing by notified body
Electrical device	Self-declaration	Testing by notified body	Testing by notified body

Pneumatic cylinders, manually and mechanically actuated valves as well as pneumatically controlled valves are classed as **non-electrical devices**. Electrically controlled valves (solenoid valves) must be considered with regard to both certification processes:

1. Base valve (**non-electric**)
2. Magnetic coil and armature system (**electrical**)

Chapter 16: Explosion protection

For this reason, there are two ATEX-relevant documents for solenoid valves.

ATEX declaration of conformity for the non-electrical part

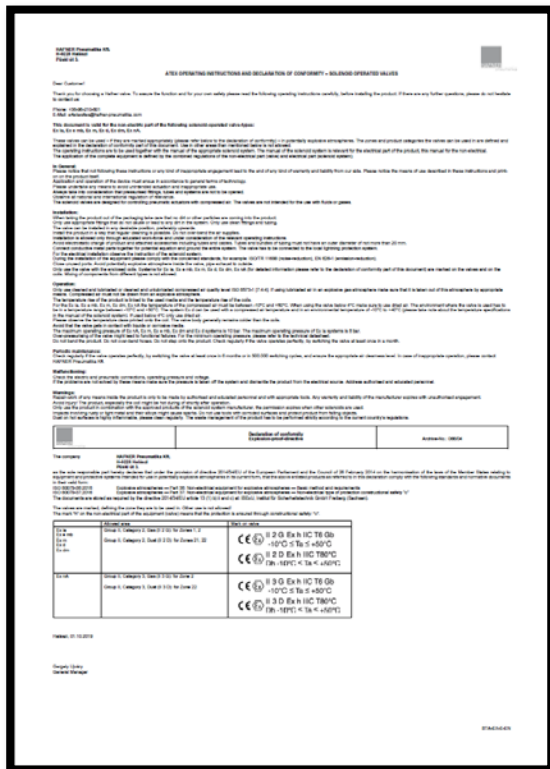

ATEX certificate for the electrical part



Non-electrical ATEX



Electrical ATEX



Chapter 16:

Explosion protection



The following illustration shows how solenoid valves are sub-divided:

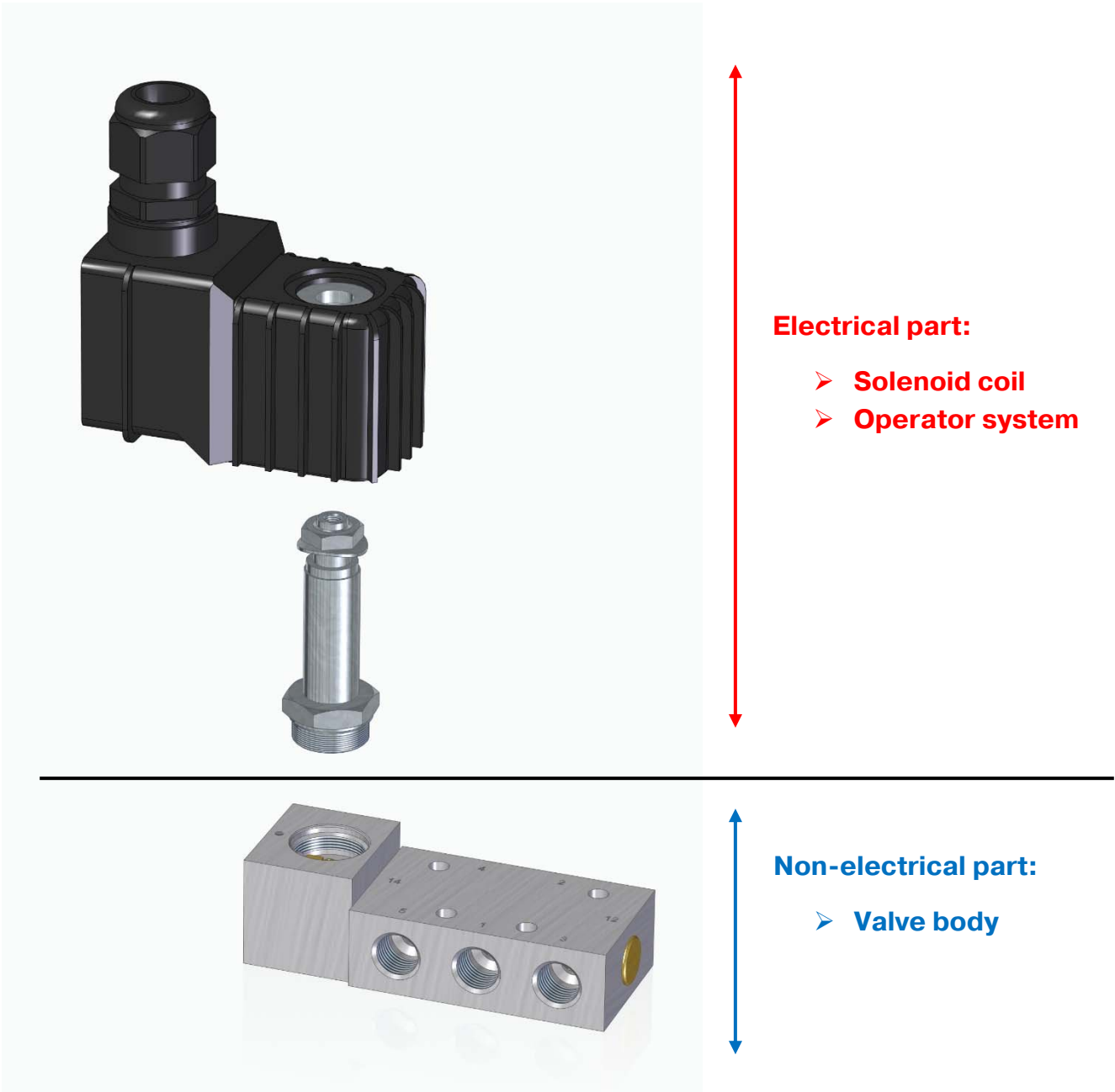

Chapter 16:

Explosion protection

Electrical and non-electrical devices are identified using the same scheme.

1. Example identification of a non-electrical device:

	II	2G	Ex	h	IIC	T6	Gb	X
	II	2D	Ex	h	IIIC	T80°C	Db	X

The two identifications differ only in terms of the type of ignition.

2. Example identification of an electrical device:

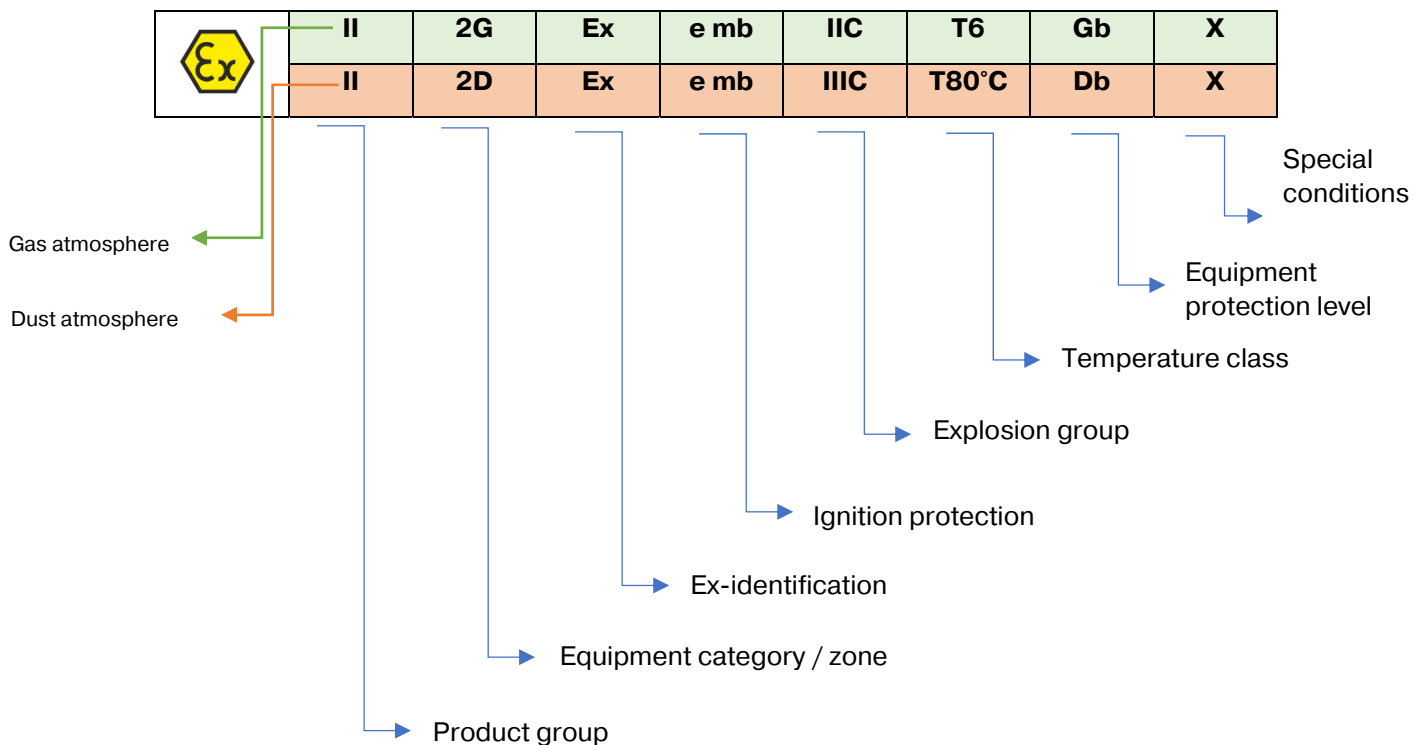

In addition, the ambient temperature in which it is permitted to be used (e.g. $-10^{\circ}\text{C} \leq T_a \leq +50^{\circ}\text{C}$) is also printed on the products.

In the case of devices that have both markings, the respective lower Ex characteristic values shall be used.

Chapter 16: Explosion protection

Example marking of ATEX components:



Chapter 16:

Explosion protection

For correct product selection it is important to know the meaning of the individual elements of the ATEX marking.

1. Product group

	II	2G	Ex	h	IIC	T6	Gb	X
	II	2D	Ex	h	IIIC	T80°C	Db	X

- **Product group I** encompasses devices that are intended for use in mining. Mine gas or combustible dust can occur here. Hafner products are not suitable for this area.
- **Product group II** encompasses all areas at risk of explosion, with the exception of mining.

2. Equipment category / zone

	II	2G	Ex	h	IIC	T6	Gb	X
	II	2D	Ex	h	IIIC	T80°C	Db	X

ATEX devices are split into three different categories per 2014/34/EU.

- **Category 1 (not covered by any Hafner devices):**
The devices guarantee a very high level of safety and are intended for use in areas where a potentially explosive atmosphere is continuously present, present for long periods of time or frequently present.
- **Category 2**
The devices guarantee a high level of safety and are intended for use in areas where a potentially explosive atmosphere is likely to occur occasionally. Devices from category 2 can also be used in category 3.
- **Category 3**
The devices offer the required level of safety in normal operation and are intended for use in areas where a potentially explosive atmosphere is not expected to occur, and where if it does occur, it is likely to do so only infrequently and for a short period of time.

The classification is to be made by the system operator.

Chapter 16:

Explosion protection

Overview of categories:

	Gases, vapours and mists	Dusts
Category 1 (Not part of the Hafner product range)	Category 1G For use in zones 0, 1 and 2	Category 1D For use in zones 20, 21 and 22
Category 2	Category 2G For use in zones 1 and 2	Category 2D For use in zones 21 and 22
Category 3	Category 3G For use in zone 2	Category 3D For use in zone 22

The zones are classified as follows:

Gases, vapours and mists	Dusts
Zone 0 Area in which a potentially explosive atmosphere consisting of a mixture of flammable substances in the form of gas, vapour or mist is continuously present with air or is present for long periods of time or frequently.	Zone 20 Area in which a potentially explosive atmosphere in the form of a cloud of combustible dust is continuously present with air or is present for long periods of time or frequently.
Zone 1 Area in which a potentially explosive atmosphere consisting of a mixture of flammable substances in the form of gas, vapour or mist is likely to occur with air in normal operation from time to time.	Zone 21 Area in which a potentially explosive atmosphere in the form of a cloud of combustible dust is likely to occur with air in normal operation from time to time.
Zone 2 Area in which a potentially explosive atmosphere as a mixture of combustible substances in the form of gas, vapour or mist with air is not expected to occur in normal operation, and if it does occur, it is likely to do so only for a short period of time.	Zone 22 Area in which a potentially explosive atmosphere in the form of a cloud of combustible dust in air is not likely to occur in normal operation, and if it does occur, it is likely to do so only for a short period of time.

Explosion protection

The following illustration shows how zones are assigned in a filling station. Accordingly, devices within the tanker and the underground tanks must be designed for zones 0 and 20. Devices in the vicinity of the fuel filling process must be designed for zones 1 and 21 and devices in the general surrounding area for zones 2 and 22.

Illustration for an area in which **explosive gases** could occur:

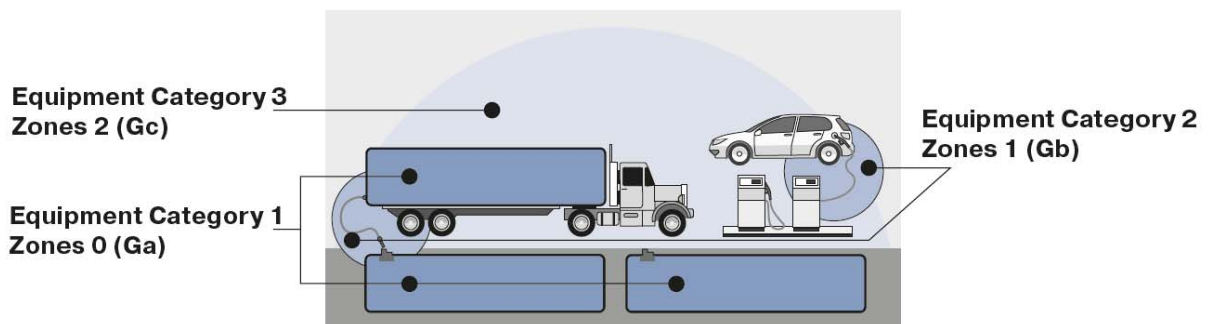
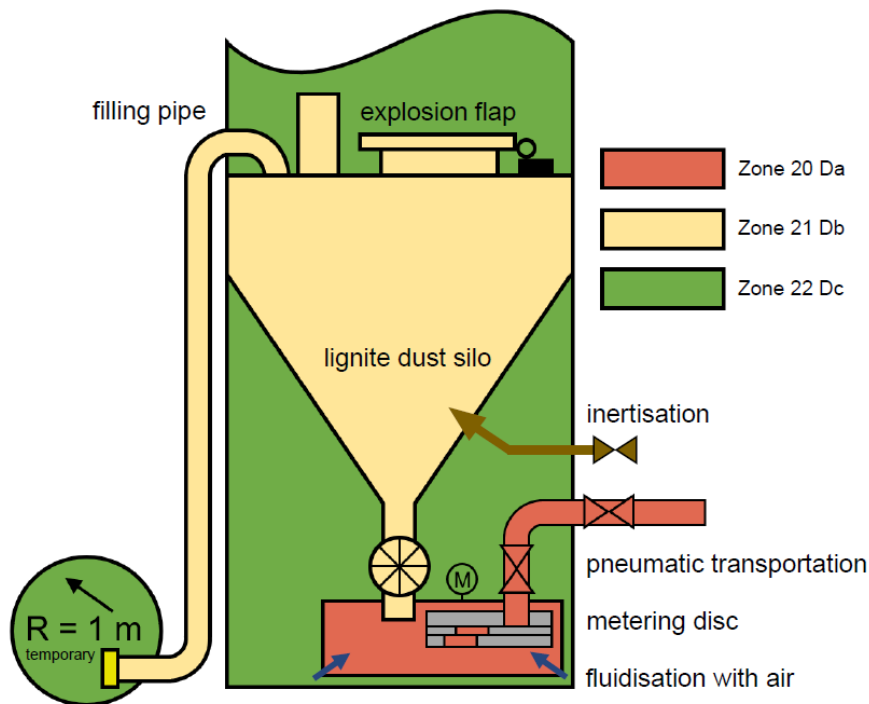



Illustration for an area in which **explosive dusts** could occur:



Chapter 16:

Explosion protection

The zone is mentioned again in the rear section of the ATEX marking, but not per ATEX, but rather per the EN ISO 80079-36 standard. Zone distribution per EN ISO 80079-36 and 2014/34/EU is identical:

	II	2G	Ex	h	IIC	T6	Gb	X
	II	2D	Ex	h	IIIC	T80°C	Db	X

EN ISO 8079-36	ATEX 2014/34/EU
EPL (Equipment protection level)	Device category / zone
Ma	M1
Mb	M2
Ga	1G
Gb	2G
Gc	3G
Da	1D
Db	2D
Dc	3D

	II	2G	Ex	e mb	IIC	T6	Gb	X
	II	2D	Ex	e mb	IIIC	T80°C	Db	X

3. Ignition protection type









Technical measures must be used to ensure that no ignition source can act upon an assumed explosive mixture, in accordance with the classification. There are multiple technical options to implement explosion protection for an electrical device. An overview of the types of ignition protection can be found in the following tables.

Pressure-tight encapsulation is often chosen for switchgear and transformers. For terminal boxes and squirrel-cage motors the measure of increased safety is often applied. Overpressure encapsulation is mainly used for equipment with higher power ratings (switchgear cabinets, large motors). Intrinsically safe circuits can only be considered for circuits with lower power ratings. This type of protection is used for measurement and control circuits as well as for the electrical connection of sensors and actuators. Here, the safety barrier is located outside the hazardous area.

Chapter 16:

Explosion protection



Overview of the types of ignition protection for **electrical** devices:

Standard	Type of ignition protection	Abbreviation	
EN 60079-6	Liquid encapsulation	ob / oc Zone: 1, 2, 21, 22	
EN 60079-2	Overpressure encapsulation	Pxb, pyb / pzc Zone: 1, 2, 21, 22	
EN 60079-5	Sand encapsulation	q Zone: 1, 2, 21, 22	
EN 60079-1	Flameproof	da / db / dc Zone: 0, 1, 2, 0, 21, 22	
EN 60079-7	Increased safety	eb / ec Zone: 1, 2, 21, 22	
EN 60079-11	Intrinsically safe	ia / ib / ic Zone: 0, 1, 2, 0, 21, 22	
EN 60079-18	Encapsulation	ma / mb / mc Zone: 0, 1, 2, 20, 21, 22	
EN 60079-31	Protection by housing IP protection and temperature limitation	ta, tb, tc Zone: 0, 1, 2, 20, 21, 22	

Chapter 16:

Explosion protection

Overview of the types of ignition protection for **non-electrical** devices:

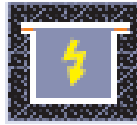
Standard	Type of ignition protection	Abbreviation	
EN 60079-2	Overpressure encapsulation	pxb, pyb / pzc Zone: 1, 2, 21, 22	
EN 60079-1	Pressure-tight encapsulation	db / dc Zone: 1, 2, 21, 22	
EN 80079-37	Non-electrical devices Constructional safety c Liquid immersion k Control of ignition sources b	h Zone: 0, 1, 2, 20, 21, 22	
EN 60079-31	Protection by housing	ta / tb / tc Zone: 0, 1, 2, 20, 21, 22	

HAFNER valves are always labelled with an "h", which stands for constructional safety. For this, the valves are considered with regard to the following possible ignition sources:

1. Hot surfaces
2. Mechanically generated sparks
3. Static electricity

Due to self-certification, the non-electrical part of our valves is restricted to zones 1, 2, 21 and 22.

Explosion protection

4. Explosion group

	II	2G	Ex	h	IIC	T6	Gb	X
	II	2D	Ex	h	IIIC	T80°C	Db	X

Depending on the type of protection, explosion-protected equipment for gases, mists and vapours is divided into three explosion groups (IIA-IIB-IIC). The explosion group is a measure of the ignition transmission capability of gases (explosive atmosphere). The requirements on the equipment increase from IIA to IIC. Classification by to **gas groups**:

Gas group device	Use in gas groups	Example	Danger of the gases
IIA	IIA	Propane	Low
IIB	IIA + IIB	Ethylene	Medium
IIC	IIA + IIB + IIC	Hydrogen	High

Combustible dusts are classified into corresponding **dust groups**:

Dust group	Use in dust group	Definition	Explanation
IIIA	IIIA	Combustible lint	Small solid particles, including fibres with a nominal size greater than 0.5 mm, which may be suspended in the atmosphere but which may settle under their own weight, which may burn or smoulder in air and which may form explosive mixtures with air at atmospheric pressure and normal temperatures.
IIIB	IIIA + IIIB	Non-conducting dusts	Combustible dust with an electrical resistance greater than 10^3 Ohm/m.
IIIC	IIIA + IIIB + IIIC	Conducting dusts	Combustible dust with an electrical resistance less than or equal to 10^3 Ohm/m.

Explosion protection

5. Temperature class

	II	2G	Ex	e mb	IIC	T6	Gb	X
	II	2D	Ex	e mb	IIIC	T80°C	Db	X

Flammable gases and vapours are divided into temperature classes in accordance with their flammability. The ignition temperature is the lowest temperature of a heated surface at which the ignition of a gas/air or vapour/air mixture occurs. In other words, it is the lowest temperature value at which a hot surface can ignite the corresponding explosive atmosphere.

The maximum surface temperature of electrical equipment must always be lower than the ignition temperature of the gas/air or vapour/air mixture in which it is used.

Equipment of a higher temperature class (e.g. T6) can therefore also be used for lower temperature classes (T1-T5).

Temperature class	Temperature range of the mix (°C)	Max. surface temperature (°C)	Typical gases
T1	≥ 450°C	450°C	Methane, acetone, ammonia, methanol, propane, acetic acid, town gas, hydrogen
T2	≥ 300 - 450°C	300°C	Ethylene, acetylene
T3	≥ 200 - 300°C	200°C	Petroleum, diesel, heating oils, hydrogen sulphide
T4	≥ 135 - 200°C	135°C	Acetaldehyde, ethyl ether
T5	≥ 100 - 135°C	100°C	
T6	≥ 85 - 100°C	85°C	Carbon disulphide

It is not possible to give generally applicable values for dust-specific characteristic values. The following table contains some limit values for corresponding products.

Explosion protection

Substance	T.ign. (°C)	T.smol. (°C)
Wood	≥ 410	≥ 200
Brown coal	≥ 380	≥ 250
Hard coal	≥ 500	≥ 240
PVC	≥ 530	≥ 340
Aluminium	≥ 560	≥ 270
Sulphur	≥ 240	≥ 250
Lycopodium	≥ 410	-

T.ign. (ignition temperature):

Lowest temperature of a hot inner wall (e.g. oven) at which the dust/air mixture ignites upon brief contact. The surface temperature must not exceed 2/3 of the ignition temperature in °C of the respective dust/air mixture, e.g.

Starch / milk powder / gelatine: Ignition temperature 390°C x 2/3
= 260°C max. permissible surface temperature

T.smol. (smouldering temperature):

The lowest temperature of a hot surface at which a layer of dust of a specified thickness (5 mm) can ignite. On surfaces where a dangerous deposit of smouldering dust cannot be effectively prevented, the surface temperature must not exceed the smouldering temperature of the respective dust, less 75K. For layer thicknesses >5 mm, a further reduction of the surface temperature is required, e.g.

Grinding dust: Smouldering temperature 290°C - 75°C
= 215 °C max. permissible surface temperature



The smouldering temperature is usually well below the ignition temperature determined for a dust cloud. The smouldering temperature decreases almost linearly with the increase in layer thickness. Safety distances must be observed for the permissible surface temperatures.

In summary, the following criteria must be taken into account for explosive environments:

Dusts	Gases, vapours and mists
<ul style="list-style-type: none"> ▪ Smouldering temperature ▪ Ignition temperature ▪ Dust group IIIA, IIIB, IIIC 	<ul style="list-style-type: none"> ▪ Flashpoint ▪ Ignition temperature ▪ Lower/upper explosion limit (concentration) ▪ Ignition energy (gas group IIA, IIB, IIC)

Hafner offers a large selection of explosion-protected valves with different types of ignition protection.





Overview table 1:

	Ex ec	Ex ia 1.6W	Ex ia 0.7W	Ex m
	Increased safety	Intrinsically safe	Intrinsically safe	Encapsulation
Page Coil	2.15.6.5.3	2.15.6.3.5	2.15.6.4.2	2.15.6.2.4
Page Valves	2.15.6.5.1 – 2	2.15.6.3.1 – 4	2.15.6.4.1	2.15.6.2.1 – 2
				
Certificates	ATEX	✓	✓	✓
	IECEX		✓	✓
	CSA / FM			
	UKCA	✓		
	CCC		on request	on request
Zone	1G		✓	✓
	2G	✓	✓	✓
	21D		✓	✓
	22D	✓	✓	✓
Temperature class	T5	T6	T6	T4
Explosion group	IIC / IIIC	IIC / IIIC	IIC / IIIC	IIC / IIIC
Temperature range	-10°C to +50°C	-40°C to +50°C	-10°C to +50°C	-20°C to +50°C
Electrical connection	Plug for 6 - 8 mm cable	Plug for 6 - 8 mm cable	Plug for 3.5 - 6 mm cable	3 metre moulded cable, 10 metres on request
Power consumption	3.0 Watts (24DC) 5 VA (24AC, 110AC, 230AC)	1.6 Watts (24DC)	0.7 Watts (24DC)	5.0 Watts (24DC) / 4.6 VA (24AC) 4.5 VA (110AC) / 5.1 VA (230AC)
IP protection class	IP 65	IP 65	IP 65	IP 65

Chapter 16:

Explosion protection

Overview table 2:

		Ex e mb	Ex dm	Ex d	Ex m CSA/FM
		Increased safety / encapsulation	Encapsulation / flameproof	Flameproof	Encapsulation
Page Coil		2.15.6.6.4	2.15.6.8.3	2.15.6.7.5	2.15.6.2.3
Page Valves		2.15.6.6.1 – 3	2.15.6.8.1 – 2	2.15.6.7.1 – 4	2.15.6.2.1 - 2
					
Certificates	ATEX	✓	✓	✓	
	IECEX	✓		✓	
	CSA / FM				✓
	UKCA				
	CCC			on request	
Zone	1G	✓	✓	✓	Class I, Zone 1, Ex m II T4 Class I, Div. 1 & Div. 2, Gr. A,B,C,D Class II, Gr. E, F, G; Class III; T4
	2G	✓	✓	✓	
	21D	✓	✓	✓	
	22D	✓	✓	✓	
Temperature class		T6	T5	T6	T4
Explosion group		IIC / IIIC	IIC / IIIC	IIC / IIIC	
Temperature range		-40°C to +50°C	-20°C to +50°C	-40°C to +50°C	-20°C to +60°C
Electrical connection		M20x1.5 6 – 13 mm	M20x1.5 6 – 8 mm	M20x1.5 or 1/2" NPT Cable gland not included	Conduit 1/2" NPT 60 cm strands
Power consumption		4,8 Watts (24, 110, 230)	3.0 Watts (12DC, 24DC) 4.8 VA (24AC, 110AC, 230AC)	2.0 Watts (24DC) 3.0 VA (110AC, 230AC)	4.5 Watts (12DC) / 4.6 Watts (24DC) 6.8 VA (110AC) / 7.7 VA (220AC, 240AC)
IP protection class		IP 65 (IP 67 optional)	IP 66	IP 67	IP 65

Chapter 16:

Explosion protection

The following tree may assist in product selection.

The following product selection tree can help to determine the correct type of ignition protection.

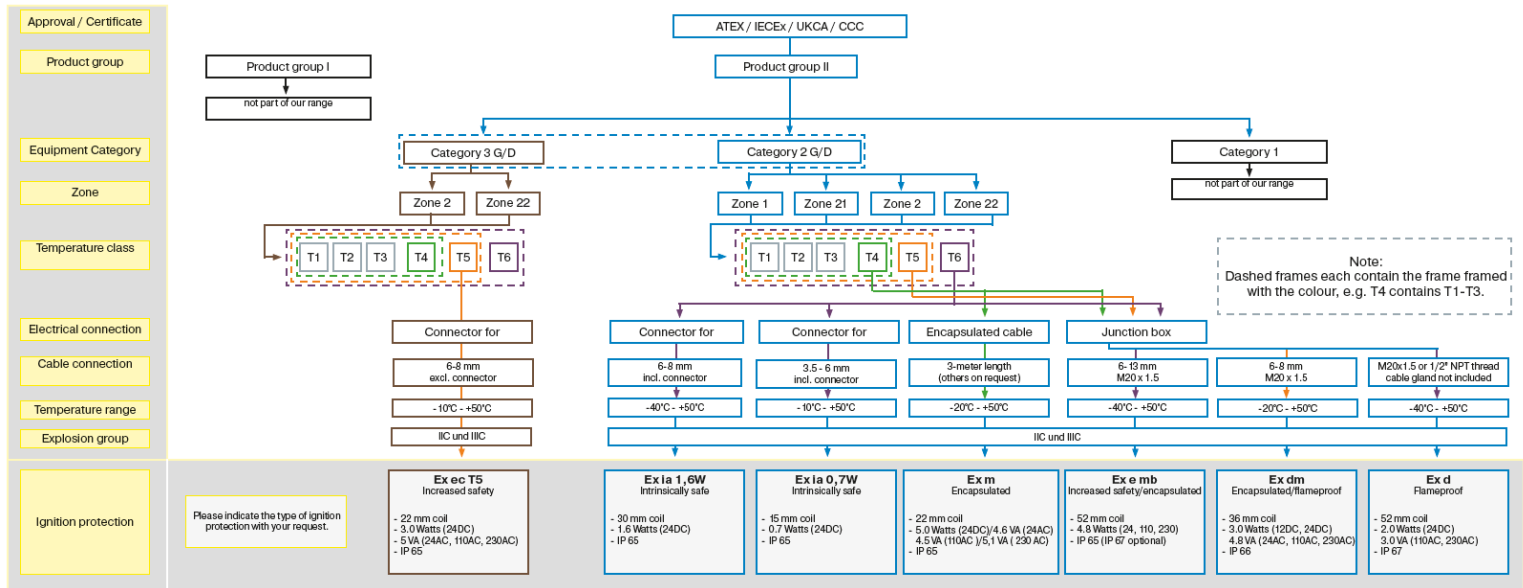

Errors and omissions excepted

Chapter 16:

Explosion protection

Explosion-proof valves from Hafner are also available with a SIL3 certificate.

Functional safety is becoming increasingly important in safety-relevant applications.

To meet this requirement, many of the Hafner valves are available with a SIL 3 certificate.

The valves are certified per **IEC 61508:2010** (1-7) by the Swiss certification company exida.



Compressed air hoses must be antistatic.

In explosion-proof environments it is important that the hoses used are **antistatic**. It is FORBIDDEN to use an electrostatic hose. In everyday life we usually perceive electrostatic charges when they are discharged. For example, when we reach for a door handle and feel a small sting on our hand.

Static charges can be very annoying during the production and processing of plastics. The charged particles can adhere to each other, attract and hold dust from the environment, making lamination or printing difficult.

- These antistatic hoses are available with the following diameters:
 - 4/2.5 black
 - 6/4 black
 - 8/6 black
 - 10/8 black
 - 12/10 black
- Pressure rating: 5 to 25 bar (depending on diameter, at 20°C)
- Temperature range: -30°C to +80°C



ATEX II 2 G/D

Chapter 16:

Explosion protection



Fittings are not covered by the ATEX directive.

Pneumatic **fittings** are non -electrical devices, therefore metal (copper) and stainless steel versions can be used in ATEX environments.



Air treatment units are generally not covered by the ATEX directive.

Most of our maintenance units are not covered by the ATEX directive, as they do not have their own potential ignition sources or internal explosive atmosphere. The following units are available:

- Filter
- Filter controller
- 2-part, 3-part units
- Pressure regulator
- Switch-on valve, start-up valve
- Accessories, containers, manometers, fastening elements



Electrically actuated maintenance units are not included. ATEX-approved units must be used for this.

All information in this training document is provided without guarantee. The system operator is responsible for selecting the correct devices in hazardous areas.